



Fitness Protocols and Guidelines for 5-18 Years



Goals

GOALS FOR ACTIVE LIFE STYLE



Kiren Rijju
Minister of State (I/C),
Youth Affairs and Sports,
Govt. of India

FOREWORD

The Fit India movement, launched in August 2019, on the occasion of National Sports Day, aims to make fitness an integral part of daily life of every Indian citizen. Hitherto, the movement has witnessed wide participation from citizens across the country in various fitness related activities being promoted by the Fit India Mission Directorate.

The movement, which is in its beginning stages, has taken one of its first strategic steps to develop age appropriate fitness protocols suited to the Indian context. These protocols include simple tests and basic guidelines that demystifies what it means to 'stay fit and active'.

I am sure these protocols and guidelines will motivate us to stay rooted to an inherently active lifestyle culture that we have had in our country.

I am happy to launch the Age Appropriate Fitness Protocols and Guidelines; it is a significant step towards achieving our mission of taking the message of fitness to the masses and building a national movement.

I hope that this protocol document becomes a handy tool for our citizens and key stakeholder institutions for the movement, not only to get themselves tested on fitness levels, but also serve as a developmental tool to improve your fitness levels and cultivate an active lifestyle.



Harsh Vardhan

Minister of Health and Family Welfare, Govt. of India

FOREWORD

India faces a double whammy on the disease front: lifestyle diseases as well as communicable diseases. It is imperative that we prepare and plan to tackle both of them to secure a strong and sustainable future for our country. It is with this vision that our Hon'ble Prime Minister launched the Fit India Movement last year. Change in mindset and culture change is critical towards achieving the Fit India Movement's mission of making fitness an integral part of our daily lives. Ministry of Health & Family Welfare is closely working with the Fit India Mission towards achieving this objective through appropriate policy measures and behaviour change campaigns.

Additionally, the COVID-19 pandemic has brought increased focus on the need to adopt sustainable practices and get back to the active lifestyle and traditionally healthy diet that has been a part of our culture since ages. It is therefore, the right time for Fit India Movement to spread awareness about the importance of physical activity and nutrition as fundamental pre-requisites to develop a strong immune system, healthy mind and body.

Keeping this aspect in mind, we realised the need for developing a standardized framework to help us define and measure the fitness of every individual. It is in this context that an expert committee was constituted to develop Age Appropriate Fitness Protocols and Guidelines for our vast population.

I am happy to launch Age Appropriate Fitness Protocols and Guidelines which the Ministry of Health & Family Welfare has jointly developed with Ministry of Youth Affairs & Sports.

I am sure that these Protocols and Guidelines will pave the way towards improved awareness about our fitness levels as well as motivate us towards adopting age-appropriate exercise and yoga asanas as part of our daily lifestyle. That would be a big step in improving the fitness level of our citizens and thus moving towards a fitter, healthier and prosperous India.

I wish all the success to every citizen in achieving an ideal fitness level.



**Ramesh Pokhriyal
Nishank**

Minister of Human
Resource Development,
Govt. of India

FOREWORD

The culture of sports and fitness farms its roots right from early childhood. 'How to Live' ought to be the first pillar of formal education. This involves teaching and practicing the art of taking care of one's body and health daily. Schools have to be the first formal institution after home where physical fitness is taught and practiced. They have to play very active role if sports and Fitness and teacher community to be taken as seriously as academics by our student.

Ministry of Human Resource Development has been actively working with the Ministry of Youth affairs Sports to achieve this vision for our country. The mission is to encourage every child to stay fit and play any sport of their choice.

I am proud of the fact that we have already launched a series of initiatives for school children as part of the Fit India Movement These include Fit India School Week, Fit India School Certification and Fit India Active Day Series which was a specially designed series to take care of children's physical and mental health during the lockdown period. Around 2.5 Lac schools have registered for the Fit India School Certification which I am sure will go a long way towards developing an education system in the country which looks at sports and fitness as an important enabler for the growth and development of our children.

As a next step, I am happy to launch Age-Appropriate Fitness Protocols and Guidelines. The protocols and guidelines will enable Physical Fitness Assessments to be conducted by schools and parents to monitor and track the fitness and health indicator of each child as per the Khelo India battery of tests for Class 1-3 (5-8 years) and Class 4-12 (9 to 18+ years). I hope that this protocol document becomes a handy pool for our Schools, Physical Education Teachers and all other stakeholders of our education system.



Ravi Mital, IAS
Secretary – Sports
Ministry of Youth Affairs and
Sports, Govt. of India

FOREWORD

Fit India Movement is a people centric movement. Under the Fit India Mission, we plan to make a behavioral change for adoption of active lifestyle.

In view of this, the Ministry of Youth Affairs and Sports is launching the Age Appropriate Fitness Protocols and Guidelines. The protocols and guidelines have been designed in a way as to enable citizens to test themselves on various parameters that define fitness, as well as simple guidelines that will ensure 30-60 minutes of moderate-to-vigorous daily physical activity. The protocols and guidelines, prepared through consultations with a wide range of experts, will facilitate our journey towards increased awareness as well as adoption of physical activities as part of our daily lives.

I look forward to working closely with various stakeholders in the coming days towards wider dissemination and use of these protocols and guidelines.



Preeti Sudan

Secretary, Ministry of
Health and Family
Welfare, Govt. of India

FOREWORD

In the present times with the changing demographic profile and disease burden and rising health care costs on account of non-communicable and chronic diseases, it's critical to move towards the delivery of a more holistic comprehensive primary health care. For primary health care to be comprehensive, it needs to encompass the preventive, promotive, curative, rehabilitative and palliative healthcare with a strong emphasis on Wellness. This amplified focus on wellness, its preventive and promotive aspects of healthcare have multiple benefits, especially in the times of COVID-19 pandemic when people are advised to stay at home and take steps to remain physically and mentally fit

Last year, our Hon'ble Prime Minister launched the nationwide "Fit India Movement" to encourage people to remain healthy and agile by including physical activity and sports in our daily lives. Fitness is an integral part of maintaining a healthy life as it impacts not just our physical well-being but our mental well-being as well.

The Ministry of Health and Family Welfare has been working closely with the Fit India Mission to increase awareness among the masses on adopting a physically active and healthy lifestyle especially through their Health and Wellness Centres.

These Age Appropriate Fitness Protocols and Guidelines have been developed for three age groups (1) 5-18 years (2) 18-64 years and (3) 65 years and above jointly by both the ministries. I urge everyone to take steps towards reaching out to its various stakeholders and ensure that these protocols and guidelines are widely disseminated and put into action.

As these Fitness Protocols and guidelines are being launched at a very apt time and scenario. I am confident that this initiative will be a very useful resource and will go a long way towards ensuring a healthier India!



Sandip Pradhan, IRS
Director General
Sports Authority of India

MESSAGE

Sports Authority of India is committed towards actualizing the Hon'ble Prime Minister's vision for making fitness an integral part of daily life of every Indian citizen. As we set out on this journey towards realizing this vision for our country, it was realized that it was important to define fitness and develop some simple and easy fitness protocols and guidelines that any common citizen could refer to.

In view of this, an expert committee was constituted by the Ministry of Youth Affairs & Sports from relevant fields to evolve Age Appropriate Fitness Protocols and Guidelines. The document, while looking at global best practices, is contextualized to the Indian context and easy to adopt.

In the coming days, Sports Authority of India intends to develop easy to follow Information, Education and Communication Materials that will facilitate easy adoption of these protocols and guidelines by our citizens.



Dr. Henk Bekedam
World Health
Organization
Representative to India

MESSAGE

Physical activity is important at every age. Apart from major health benefit, Physical activity has numerous other social, environmental and economic benefits and is intrinsically linked with the achievement of the Sustainable Development Goals. The Global Action Plan for Noncommunicable Disease which is endorsed by United Nations General Assembly, sets a goal of a 10% reduction in levels of physical inactivity by 2025 along with other targets to prevent premature mortality.

The Fit India Movement, a national-wide movement, that promote physical activities and sports in daily lives is a well-timed opportunity to increase the awareness at the community level with provision to increased access to fitness services.

The Age appropriate protocols and guidelines developed by Fit India Mission, Ministry of Youth Affairs and Sports are comprehensive and aims to promote physical activity in multiple settings. These guidelines are a step forward to create active people and societies by encouraging physical activity among people of all ages and abilities.

WHO India sincerely believe that Fitness Protocols and Guidelines will help in measuring and improving the physical activity level at all levels. We appreciate the efforts of Fit India Team in drafting much needed country appropriate physical activity /fitness guidelines.



Dr. K K Deepak
Chairman, Expert
Committee for
development of Fitness
Protocols

MESSAGE

Physical Fitness is a necessity to enable us to perform and carry out all our activities of life. Human wellbeing is always desirable in all age groups. It has been expressed beautifully and very appropriately by our celebrated poet Kavi Kalidas.

'शरीरमाद्यं खलु धर्मसाधनम्
(*Kumārasambhava*, [Kālidāsa](#)) [5.33]

It means that the body is the foremost medium to perform Dharma (duties).

If we are healthy and physically fit, we can perform our responsibilities effectively- be it personal, social or official. Physical fitness is natural and comes easy way. Each one of us can enjoy good physical fitness provided one pays attention to it on regular basis towards achieving set goals.

Maintaining and improving physical fitness is a simple process to practise. One can remain physically fit throughout to enjoy a meaningful life. Human body is like a machine which keeps on working efficiently. However, like any other machine it needs maintenance which can be done comfortably with a little effort.

The present *Fitness Protocols and Guidelines* for imparting and measuring physical fitness are designed towards achievable set goals which are easy, comprehensive and practical for all age groups.

Expert Committee

The following members of the Expert Committee for development of Fitness Protocols for different age groups were involved in the finalization of the fitness protocols and drafting of the document.

	Name	Designation
1	Dr. K.K. Deepak <i>Chairman of the Committee</i>	Prof. and Head of the Department (Physiology), AllMS, New Delhi
2	Ms. Ekta Vishnoi	Mission Director, Fit India Mission
3	Dr. L. Swasticharan	CMO, (LS) Health & Family Welfare Representative of Ministry of Health and Family Welfare
4	Dr. Y. Venkata Ramana	Scientist, G (Director Grade) & Head – Dept. of Work Physiology and Sports Nutrition and MYA-NIN Department of Sports Science, ICMR, National Institute of Nutrition
5	Dr. Manjit Singh	Deputy Secretary, (PE & Sports), CBSE Representative of Ministry of Human Resources Development
6	Col. Bibhu Nayak	Advisor, Sports Injury Centre Safdarjung Hospital Representative of Ministry of Human Resources Development
7	Dr. P Majumdar	Head of Sports Science, Sports Authority of India
8	Dr. H. Sreedhar	Sports Science Expert, TransStadia Member of 'Khelo India Fitness Assessment Protocols' Committee
9	Mr. I.V. Basavaraddi	Advisor, Ministry of AYUSH
10	Mr. Sujit Panigrahi	CEO, Fitness365 Leads Khelo India Fitness Assessment Program, Sports Authority of India

Acknowledgements

On behalf of the Committee constituted for the 'Development of Age Appropriate Fitness Protocols', I thank all individuals and institutions who have contributed to the consultations and deliberations that has gone behind developing the protocols. First and foremost, I would like to profoundly thank Shri R.S.Julaniya, Former Secretary, Department of Sports, Government of India for his dynamic leadership and steadfast support during his tenure as Secretary, Sports. Next, I express my gratitude to Dr. Manohar Agnani, Joint Secretary, Ministry of Health and Family Welfare for his warm encouragement and timely support. I would also like to express sincere thanks towards Shri L.S. Singh, Joint Secretary, Department of Sports for his guidance right from the conception stage.

Next, I owe my deepest gratitude to Shri Rohit Khanna, Chief Executive Officer, Fit India Mission, Dr. Harshvardhan Nayak, Technical Consultant, Ministry of Health and Family Welfare, Ms. Sobika Rao, Assistant Professor, Morarji Desai National Institute of Yoga, Dr. Subham Badhyal, Senior Research Officer, Sports Science, Sports Authority of India and Shri Shailendra Maurya, Section Officer (Sports Department), CBSE, Mr. Vishnu Sudhakaran, Deputy Director, Fit India Mission and Dr. Pankaj Aggarwal, Public Health Expert- Non Communicable Diseases project, Tata Trusts supporting Ministry of Health and Family Welfare for their active participation in various meetings of the Committee, their ideas and practical inputs has helped to formulate and finalise these protocols.

Finally, my heartfelt appreciation goes to project NISHTHA/Jhpiego for their creative work and excellent layout designs, Shri. Kunal Patadia and Shri. Mayank Choudhary for their secretarial assistance and coordination work.

Ekta Vishnoi

Mission Director – Fit India



Table of Contents

Expert Committee	9
Acknowledgement.....	10
1. Overview	14
1.1 Purpose of the Program	14
1.2 Key Objectives.....	14
1.3 Developmental Goals for Children	15
2. Physical Fitness Assessment	17
2.1 Battery of Tests for Age Group 5-8 Years Class 1 To 3.....	17
2.2 Battery of Tests for Age Group: 9-18+ Years Class 4 To 12	17
3. Test Descriptions for Children.....	18
3.1 Body Composition (Body Mass Index or BMI)	18
3.2 Coordination (Plate Tapping Test)	20
3.4 Abdominal/Core Strength (Partial Curl Up - 30 seconds).....	22
3.5 Muscular Endurance (Push Ups for Boys/Modified Push Ups for Girls).....	23
3.6 Flexibility (Sit and Reach)	25
3.7 Cardiovascular Endurance (600 m Run/Walk).....	27
3.8 Speed (50 m Dash).....	28
4. Fitness Protocols	29
4.1 Activities for Age 5-8 yrs (Class 1-3) - Focus on Fundamental Movement Skills	29
Activity 1: Walking on Heels	30
Activity 3: Running & Jumping	31
Activity 4: Animal Walk.....	31
Crab Walk	31

Bear Walk	32
Activity 5: Static Balance: Standing like a Stork	32
Activity 6: Skipping	33
Activity 7: Throwing and Catching	33
Activity 8: Zigzag Running	33
Activity 9: Jumping Jacks	34
Activity 10: Shuttle Run	34
Activity 11: Stretching	35
Cat & Cow Pose	35
Activity 12: Chasing Games (Pakda Pakdi, Hide & Seek, Chain Chain, 7 Stones)	36
Activity 13: Relay Races (3 Legged Race, Lemon Race, Sack Race, Ball Carry).....	37
4.2 Activities for Age 9-18 years (Class IV to XII) - Focus on Sports Skills Development	38
4.3 Suggested Fitness Exercises for Age 9-14 (Class 4-8)	39
4.3.1 Endurance related Activities	39
4.3.2 Strength related Activities.....	40
4.3.3 Flexibility related Activities.....	41
4.4 Suggested Fitness Activities for age 15-18 (Class 9-12).....	42
4.4.1 Endurance and speed related Activities	42
4.4.2 Strength related Activities.....	43
4.4.3 Flexibility related Activities.....	44
5. Age-appropriate Yoga Protocols.....	45
5.1 Yoga protocol for Age of 5-8 Years (Class 1-3).....	45
5.2 Yoga protocol for Age of 9-18 Years(Class 4-12)	46
6. Guidelines & Safety Considerations	47
6.1 Environmental Consideration	47
6.2 Warm up	47
6.3 Hydration	47

6.4 Cool Down.....	47
6.5 Other Considerations	47
7. Benchmarks for Fitness Tests	48
7.1 Description of Fitness Indicators.....	48
7.2 Coordination Test - Plate Tapping for Boys	48
7.3 Coordination Test - Plate Tapping for Girls.....	48
7.4 Balance Test - Flamingo Balance Test Boys.....	49
7.5 Balance Test - Flamingo Balance Test Girls	49
7.6 Abdominal/Core strength - Partial Curl-up for Boys	49
7.8 Abdominal/Core strength - Partial Curl-up for Girls.....	50
7.9 Muscular Endurance - Push-ups for Boys.....	50
7.10 Muscular Endurance - Modified Push-ups for Girls	51
7.11 Flexibility Test - Sit and Reach for Boys (9-18 years).....	51
7.12 Flexibility Test - Sit and Reach for Girls (9-18 years)	52
7.13 Cardiovascular Endurance - 600 m Run/Walk - Boys.....	53
7.14 Cardiovascular Endurance - 600 m Run/Walk - Girls	53
7.15 Speed Test - 50 m Dash - Boys.....	54
7.16 Speed Test - 50 m Dash - Girls	55
7.17 Body Mass Index.....	57



1. Overview

The Fitness Program for children focuses on developing motor skills, knowledge of physical education and Sports Skills, which is implemented and evaluated in a progressive and developmentally appropriate manner.

Successful participation in specific physical activities requires the acquisition and mastery of appropriate fundamental and specialised skills (e.g. overhead strike with a racket, backhand throw with a disc, in-step kick with a ball, front-crawl, stroke with bat/racquet, a specific step with dance and music).

1.1 Purpose of the Program

The purpose is to enable the children to demonstrate individually and in groups (with others), the physical skills, practices and values to enjoy an active healthy lifespan.

1.2 Key Objectives

- 1. Ensure 60 Minutes of Moderate-to-vigorous Physical Activity (MVPA) Per Day**
- 2. Promote 'Fitness for All'**
- 3. Institution of Age-appropriate, Progressive Curriculum:**
 - a. Children of Class Nursery to III to perform variety of fundamental movement skills
 - b. All Children from Class VI onwards to get intervention aimed at improving their fitness levels, competency in sports skills and techniques of children
 - c. Age-appropriate Physical Activities and Exercises to include flavours of
 - i. Recreational Games
 - ii. Modern Sports and Traditional Games
 - iii. Dance
 - iv. Yoga
 - v. Free-hand exercises
- 4. Fitness Assessment Report Card for every Child (Class 1-12):**
 - a. Physical Fitness Assessments will be conducted by School for each Student by trained staff to Track the fitness level and health indicator of each child as per the **Khelo India battery of tests for Class 1-3 (5-8 years) and Class 4-12 (9 to 18+ years)**
 - b. Assessment of children by their parents
- 5. Create a System for Monitoring:** Tracking the overall improvements of the school as well as each class and children. Re-evaluate Intervention Strategy
- 6. Develop system for regular feedback and program re-evaluation strategy**

1.3 Developmental Goals for Children

	Fitness and Active Lifestyle	Sports Pursuit	Participation in Competitions
Class I- III (Age 5 - 8 years)	<p align="center">Movement Education</p> <p>Acquisition of fundamental motor skills and movement concepts - Body, Space and Effort Awareness</p> <p>Emphasis on learning and enjoyment through developmentally appropriate movement experiences</p>		
Class IV - VIII (Age 9-14 years)	<p align="center">Broad-Based Development</p> <p>Acquisition of overall skills and concepts (within physical activities and sports)</p> <p>Emphasis on Involvement in a range of physical and sporting experiences that are fun and inclusive</p> <p>Understanding of principles of training and safe practices</p> <p>Anchored on core values (respect, responsibility, resilience, integrity, care and harmony)</p>		
Class IX - XII (Age 15-18 years)	<p>Recreational Participation#</p> <p>Development of physical activity- and/or sport specific skills and tactics</p> <p>Sustained involvement in physical activities and/or sports based on interest and competencies</p> <p>Application of principles of training and safe practices</p> <p>Maintenance of health and skill-related fitness</p>	<p>Application of training in competitions. Winning to be a secondary emphasis.</p> <p>Development of mental skills</p> <p>Emphasis on sport-specific strength and fitness conditioning</p>	
		<p>Specialisation*</p> <p>Consolidation of one or two sport-specific skills and tactics for those who have Sports Talent</p>	<p>High Performance**</p> <p>High amount of performance-based training and competition Focus on one sport</p>

More emphasis to be given to participation of 'all children' and fun part of the modified games, sports and different kinds of physical activities. Fitness for All and Good Social Behaviour has to be a key outcome of the whole class/school.

* Specialisation to be only for students who have sports talent and want to compete at higher levels. Compulsory and rigid sports specialization should be avoided for all children, as it has been reported to result in significant sports injuries, especially chronic and overuse injuries.

*** This should be for selected few on the basis of their potential and past records. Generalization can be avoided for all the students. All the general principles of sports performance enhancement as applicable for any other elite players may be applied with sufficient modification including the concept of periodization.*

Fitness defines the ability to perform physical activity, and encompasses a wide range of abilities. Each activity and sports require a specific set of skills and fitness level. Fitness is generally divided into specific fitness categories or components, and each can be tested and trained individually.

The concept of Health-related Physical Fitness Components can be incorporated in Schools as Developmental Goals.

1. Health-related Physical Fitness Components:

- a. Cardiorespiratory endurance,
- b. body composition,
- c. muscular strength,
- d. muscular endurance
- e. flexibility.

2. Skill-related Physical Fitness Components:

- a. Speed
- b. Agility
- c. Coordination
- d. Balance
- e. Power
- f. Reaction time

Schools may like to do assessment independently/ tracking of improvement in these parameters for overall development of children.



2. Physical Fitness Assessment

The following Khelo India battery of Fitness Assessment Tests has been finalized by the Expert Committee of Physical Fitness Assessment:

2.1 Battery of Tests for Age Group 5-8 Years | Class 1 To 3

At primary class 1-3, children should acquire Fundamental Movement Skills (FMS) leaving the learning of specific physical activities to later stages. FMS provide the building blocks for many physical activities, such as playing games, dance, and sport. Locomotor, Manipulative & Body Management abilities are key to success in most sports and physical activities. The following are the abilities of children in class 1-3 which need to be measured and tracked which are important for controlling the body in various situations:

1. Body Composition (BMI)
2. Coordination (Plate Tapping)
3. Balance (Flamingo Balance)

2.2 Battery of Tests for Age Group: 9-18+ Years | Class 4 To 12

For Class 4 to 12, it is important for Children to have an overall physical fitness. The following Components are to be considered in Physical Health and Fitness Profile:

1. Body Composition (BMI)
2. Muscular Strength and Endurance
 - a. Abdominal/Core Strength (Partial Curl-up)
 - b. Muscular Endurance (Push Ups for Boys, Modified Push Ups for Girls)
3. Flexibility (Sit and Reach Test)
4. Cardiovascular Endurance (600 M Run/Walk)
5. Speed (50 m Dash)

The tests are being done by schools across India through **Khelo India Assessor App (School Version) - available on Google Play Store**. Children are given a Fitness Assessment Report Card at the end of Term 1 and Term 2.

Schools and Parents have individual User ID and Password, with access to schoolfitness.kheloindia.gov.in and Khelo India App respectively where they can see detailed Report Cards and history.



3. Test Descriptions for Children

3.1 Body Composition (Body Mass Index or BMI)

What does it measure:	
<p>Body Composition refers primarily to the distribution of muscle and fat in the body. Body size such as height, length and girth are also grouped under this component.</p> <p>The test performed is Body Mass Index (BMI), which is calculated from body Weight (W) and height(H). $BMI = W / (H \times H)$, where W = body weight in kilograms and H = height in meters. The higher the score usually indicates higher levels of body fat.</p>	
Measuring Height Accurately	Infrastructure/Equipment Required:
<p>Remove the participant's shoes, bulky clothing, and hair ornaments, and unbraid hair that interferes with the measurement.</p> <p>Take the height measurement on flooring that is not carpeted and against a flat surface such as a wall with no molding.</p> <p>Have the participant stand with feet flat, together, and back against the wall. Make sure legs are straight, arms are at sides, and shoulders are level.</p> <p>Make sure the participant is looking straight ahead and that the line of sight is parallel with the floor.</p> <p>Take the measurement while the participant stands with head, shoulders, buttocks, and heels touching the flat surface (wall). (See illustration.) Depending on the overall body shape of the participant, all points may not touch the wall.</p> <p>Use a flat headpiece to form a right angle with the wall and lower the headpiece until it firmly touches the crown of the head.</p> <p>Make sure the measurer's eyes are at the same level as the headpiece.</p>	<p>Flat, Clean surface, Weighing Machine, Stadiometer/Measuring Tape pasted on a wall</p>
	Scoring:
	 <p>Height recorded in cm and mm. Accurately record the height to the nearest 0.1 centimeter.</p>

Lightly mark where the bottom of the headpiece meets the wall. Then, use a metal tape to measure from the base on the floor to the marked measurement on the wall to get the height measurement.

Accurately record the height to the nearest 0.1 centimeter.

Measuring Weight Accurately

Use a digital scale. Avoid using bathroom scales that are spring-loaded. Place the scale on firm flooring (such as tile or wood) rather than carpet.

Have the participant remove shoes and heavy clothing, such as sweaters.

Have the participant stand with both feet in the center of the scale.

Record the weight to the nearest decimal fraction (for example, 25.1 kilograms).

Weight will be recorded in kilogram (kg) and grams (gms). Record the weight to the nearest decimal fraction (eg, 25.1 kilograms).

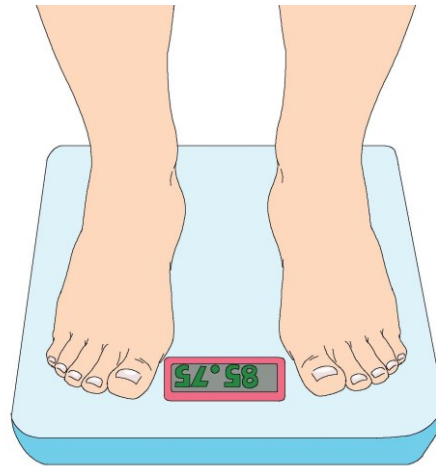

How to conduct: https://youtu.be/mVGfZ0_ki7M

3.2 Coordination (Plate Tapping Test)

What does it measure: Tests speed and coordination of limb movement	
How to Perform: If possible, the table height should be adjusted so that the subject is standing comfortably in front of the discs. The two yellow discs are placed with their centers 60 cm apart on the table. The rectangle is placed equidistant between both discs. The non-preferred hand is placed on the rectangle. The subject moves the preferred hand back and forth between the discs over the hand in the middle as quickly as possible. This action is repeated for 25 full cycles (50 taps).	Infrastructure/Equipment Required: Table (adjustable height), 2 yellow discs (20cm diameter), rectangle (30 x 20 cm), stopwatch Scoring: The time taken to complete 25 cycles is recorded  How to conduct: https://youtu.be/7iXA_PMqok8
Administrative Suggestion: Participants should be encouraged to stand in a balanced posture, feet apart to shoulder width. Results are usually better if the participant can maintain constant pace during most of the run.	
Suggested Physical activities to improve Coordination (plate tapping test) : You can improve by practicing paper airplane throw, handkerchief catch, Frisbee, ruler drop.	

3.3 Static Balance (Flamingo Balance Test)

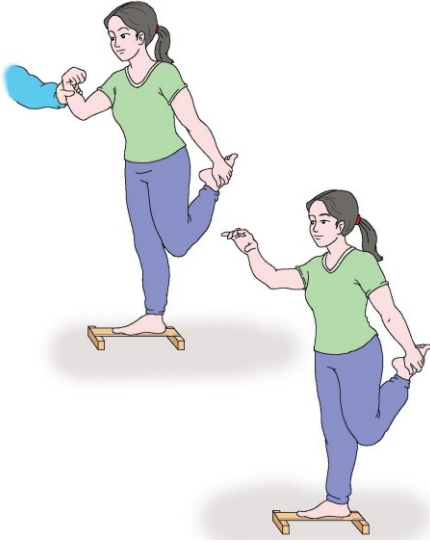
What does it measure:	
Ability to balance successfully on a single leg. This single leg balance test assesses the strength of the leg, pelvic, and trunk muscle as well as static balance.	
How to Perform: Stand on the beam. Keep balance by holding the instructor's hand (if required to start). While balancing on the preferred leg, the free leg is flexed at the knee and the foot of this leg held close to the buttocks. Start the watch as the instructor lets go of the participant/subject. Pause the stopwatch each time the subject loses balance (either by falling off the beam or letting go of the foot being held). Resume over, again timing until they lose balance. Count the number of falls in 60 seconds of balancing. If there are more than 15 falls in the first 30 seconds, the test is terminated.	Infrastructure/Equipment Required: Non Slippery even surface, Stopwatch, can be done by just standing on a beam. Scoring: The total number of falls or loss of balance in 60 seconds of balancing is recorded. If there are more than 15 falls in the first 30 seconds, the test is terminated.
	
	How to conduct: https://youtu.be/LN72M7lj6tg
Administrative Suggestion: Participants should be encouraged to focus eyes on stationary objects straight ahead.	
Suggested Physical activities to improve Balance (Flamingo Test) To improve balance, you should practice one foot balance, walking on toes and heel toe walking, walking on straight lines, skipping, hopping, vrikshasana, walking on beam etc.	

3.4 Abdominal/Core Strength (Partial Curl Up - 30 seconds)

<p style="text-align: center;">What does it measure:</p> <p style="text-align: center;">The curl up test measures abdominal muscular strength and endurance of the abdominals and hip-Flexors, important in back support and core stability.</p>	
<p>How to Perform:</p> <p>The subject lies on a cushioned, flat, clean surface with knees flexed, usually at 90 degrees, with hands straight on the sides (palms facing downwards) closer to the ground, parallel to the body.</p> <p>The subject raises the trunk in a smooth motion, keeping the arms in position, curling up the desired amount (at least 6 inches above/along the ground towards the parallel strip).</p> <p>The trunk is lowered back to the floor so that the shoulder blades or upper back touch the floor.</p>	<p>Infrastructure/Equipment Required:</p> <p>Flat clean cushioned surface with two parallel strips (6 inches apart), Stopwatch</p> <p>Scoring:</p> <p>Record the maximum number of Curl ups in a certain time period 30 seconds.</p> <div style="text-align: center;">  <p>How to conduct: https://youtu.be/Apz7MH3dO-M</p> </div>
<p>Administrative Suggestion:</p> <p>Participants should be encouraged to keep normal breathing rate. Results are usually better if the participant can maintain constant pace during the activity.</p>	
<p>Suggested physical activities to improve abdominal strength (partial curl ups) and muscular endurance (push ups/ modified push ups for girls)</p> <ol style="list-style-type: none"> 1. You need to Practice climb stairs, hill walk, cycling, dance, push ups, sit ups, squats, planks, crunches, Naukasana, Shalabhasana, Akarna Dhanurasana etc.. to build strength. 2. You need to practice Tadasana, Vrikshasana, Utkatasana, Trikonasana, Katichakrasana, Yoga Mudrasana, Quarter squat, Climb stairs, Crunches and Back extension exercise. 	

3.5 Muscular Endurance (Push Ups for Boys/Modified Push Ups for Girls)

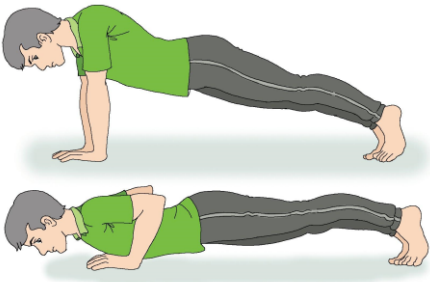
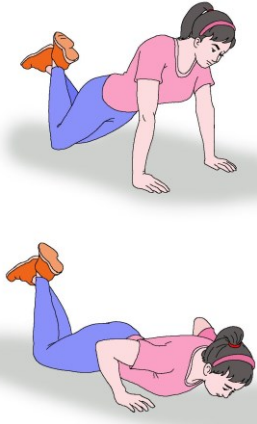
What does it measure: Upper body strength, endurance, and trunk stability.	
<p>How to Perform:</p> <p>A standard push up begins with the hands and toes touching the floor, the body and legs in a straight line, feet slightly apart, the arms at shoulder width apart, extended and at a right angle to the body.</p> <p>Keeping the back and knees straight, the subject lowers the body to a predetermined point, to touch some other object, or until there is a 90-degree angle at the elbows, then returns back to the starting position with the arms extended.</p> <p>This action is repeated, and the test continues until exhaustion, or until they can do no more in rhythm or have reached the target number of push-ups.</p> <p>For girls: push-up technique is with the knees resting on the ground.</p>	<p>Infrastructure/Equipment Required: Flat clean cushioned surface/Gym mat</p> <p>Scoring: Record number of correctly completed push ups.</p> <p style="text-align: center;">For boys</p>  <p style="text-align: center;">For girls</p>  <p>How to conduct: https://youtu.be/wDPMtXeGuUo</p>
<p>Administrative Suggestion:</p> <p>Participants should be encouraged to emphasize to keep the back straight. Results are usually better if the participant can maintain constant pace during the activity.</p>	

Suggested physical activities to improve abdominal strength:

1. You need to Practice climb stairs, hill walk, cycling, dance, push ups, sit ups, squats, planks, crunches, Naukasana, Shalabhasana, Akarna Dhanurasana etc., to build strength.
2. You need to practice Tadasana, Vrikshasana, Utkatasana, Trikonasana, Katichakrasana, Yoga Mudrasana, Quarter squat, Climb stairs, Crunches and Back extension exercise.

You may also like to additionally measure muscular strength using these test protocols:

1. Vertical jump test (lower limb explosive power and strength)
2. Hand grip strength (grip strength)
3. Press up test; push ups tests etc. one test may be chosen targeting major muscle groups of the body like upper limb, lower limb, core and abdomen, back etc.

3.6 Flexibility (Sit and Reach)

What does it measure:

Common measure of flexibility, and specifically measures the flexibility of the lower back and hamstring muscles. This test is important as because tightness in this area is implicated in lumbar lordosis, forward pelvic tilt and lower back pain

How to Perform:

This test involves sitting on the floor with legs stretched out straight ahead. Shoes should be removed. The soles of the feet are placed flat against the Sit and Reach box. Both knees should be locked and pressed flat to the floor - the tester may assist by holding them down.

With the palms facing downwards, and the hands on top of each other, the subject reaches forward along the measuring line as far as possible.

Ensure that the hands remain at the same level, not one reaching further forward than the other. After some practice reaches, the subject reaches out and holds that position for one-two seconds while the distance is recorded. Make sure there are no jerky movements.

It is crucial that the vertical plane against which the subject's feet will be placed is exactly at the 23 cm mark of the Sit and Reach box.

Infrastructure/Equipment Required:

Flat clean cushioned surface/Gym Mats, Sit and Reach box with the following dimensions: 12" x 12" (sides) 12" x 10" (front and back) 12" x 21" (top) Inscribe the top panel with centimeter/mm gradations.

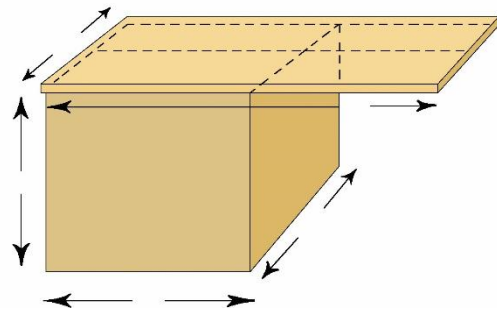

Scoring:

The score is recorded (difference between initial position and final position), in cm and mm, as the distance reached by the hand.

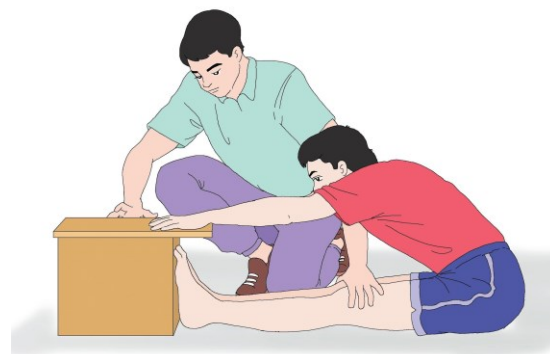

How to conduct: <https://youtu.be/nv7HEw-a-Yw>

Administrative Suggestion:

Proper warm-up and static stretching of the lower back and posterior thighs is very important for this test. A partner placing his/her hands lightly across knees can prevent the flexing of knees.

Keep hands over each other (fish pose). In order to prevent the test apparatus from sliding away during the test, it should be placed against a wall or a similar immovable object.

The test trial is repeated if:

1. The hands reach out unevenly or
2. The knees are flexed at the time of doing the test.

Suggested physical activities to improve flexibility: You need to do stretching by toe touching, climbing stairs, Chakrasana, Halasana, Paschimottanasana, Hastottanasana, Trikonasana, Katichakrasna, Tadasana, Tai-chi and pilates on regular basis to develop flexibility.

3.7 Cardiovascular Endurance (600 m Run/Walk)

What does it measure: Cardiovascular Fitness/Cardiovascular Endurance	
How to Perform: Participants are instructed to run 600 m in the fastest possible pace. The participants begin on signal (Starting point)- "ready, start". As they cross the finish line, elapsed time should be announced to the participants. Walking is permitted but the objective is to cover the distance in the shortest possible time.	Infrastructure/Equipment Required: Stopwatch, whistle, marker cone, lime powder, measuring tape, 200 or 400 m with 1.22 mt (minimum 1 mt) width preferably on a flat and even playground with a marking of starting and finish line. Scoring: Time taken for completion (Run or Walk) in min, sec, mm  How to conduct: https://youtu.be/fD6gFP6srgQ
Administrative Suggestion: Participants should be encouraged to practice running with emphasis placed on the concept of pace. Results are usually better if the participant can maintain constant pace during most of the run and perhaps using a strong closing effort.	
Suggested physical activities to improve cardiovascular endurance (600 m run/walk): You can do pranayam (kapalbhati, bhastrika, bhramari), road cycling, swimming, aerobics, running and dancing to improve endurance.	

3.8 Speed (50 m Dash)

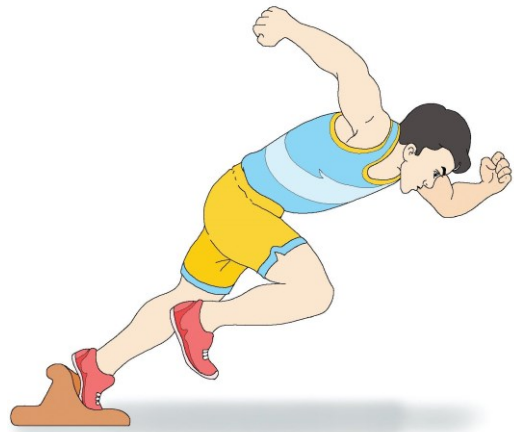
What does it measure: Determines acceleration and speed	
How to Perform: A thorough warm up should be given, including some practice starts and accelerations. Start from a stationary position, with one foot in front of the other. The front foot must be on or behind the starting line. This starting position should be static (dead start). The tester should provide hints for maximizing speed (such as keeping low, driving hard with the arms and legs) and encourage to continue running hard through the finish line.	Infrastructure/Equipment Required: Measuring tape or marked track, stopwatch, cone markers, flat and clear surface of at least 60 m. Scoring: Time taken for completion  How to conduct: https://youtu.be/V7SHY_n7n2A
Administrative Suggestion: Participants should be encouraged to practice running with emphasis placed on the concept of pace. Results are usually better if the participant can maintain constant pace during most of the run and perhaps using a strong closing effort.	
Suggested physical activities to improve speed (50-m standing dash): You can practice quick sprints, frog hops and one leg hops to improve speed. You can also do leg stretching to increase stride length which in turn improves speed. Additionally, you can practice 10m shuttle run, zigzag run, agility hurdles, Two Jumps Forward, One Jump Back, Squat Out / Hop In, Lateral Jumps with Agility Ladder, criss cross rope jumping to improve speed along with change in direction (agility).	



4. Fitness Protocols

WHO Guidelines on Physical Activity and Sedentary Behavior 2020

Age Appropriate Fitness Protocols and Guidelines for age 5-18 years

1. At least an average of 60 minutes per day of moderate-to-vigorous intensity physical activity, across the week; most of this physical activity should be aerobic.
2. Vigorous-intensity aerobic activities, as well as those that strengthen muscle and bone should be incorporated at least 3 days a week.

4.1 Activities for Age 5-8 yrs (Class 1-3) - Focus on Fundamental Movement Skills

The focus is on the development of key Fundamental Movement Skills which are required for life. Fit India recommends the following activities for improvement of fitness for the 5-8 age groups:

1. Locomotor Skills

- a. Walking
- b. Running
- c. Leaping / Jumping
- d. Hopping / Skipping / Galloping
- e. Sliding / Crawling / Rolling/rotating

2. Manipulative Skills

- a. Throwing
- b. Catching
- c. Bouncing / Dribbling
- d. Trapping
- e. Kicking with Hand / with leg
- f. Volleying
- g. Striking etc.

3. Body Management/Non-locomotor Skills

- a. Curling
- b. Stretching
- c. Twisting / turning / spinning

- d. Pushing / Pulling
- e. Rocking
- f. Swinging / pivoting
- g. Balancing / counter balancing
- h. Counter-tension etc.)

The four broad categories of movement concepts are taught:

Body awareness	Space awareness	Effort awareness	Relationship awareness
(what the body is doing)	(where the body and object is moving)	(how the body is moving)	(with whom or what the body is relating to as it moves)

These skills taught in Class 1-3 are fundamental to learning any sports, physical, recreational, dance related activities. All activities are fun and inclusive. Activities range from Athletics, Education Gymnastics, Recreational and Minor/Adapted Games, Traditional Game forms, Health and Nutrition, Dance etc. Activities which are recommended for improvement of FMS:

Activity 1: Walking on Heels

Having good balance is important for many everyday activities, such as going up and down stairs.

How to Perform:

1. Position the heel of one foot just in front of the toes of the other foot. Your heel and toes should touch or almost touch.
2. Choose a spot ahead of you and focus on it to keep you steady as you walk.
3. Take a step. Put your heel just in front of the toe of your other foot.
4. Repeat for 20 steps



Activity 2: Crouch Forward & Backward

How to Perform:

1. Get down into a crouching position.
2. Simply walk forward as far as you can, maintaining the crouch position.
3. Shoot for 30 seconds continuously and complete 3 sets
4. Repeat the same now in a backward position, i.e. try going back in the same crouching position.

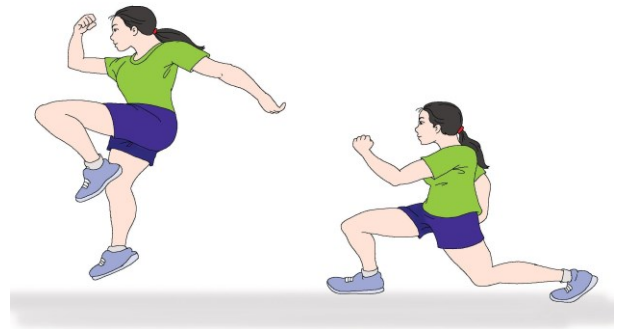

Activity 3: Running & Jumping

How to Perform:

1. Run Forwards (1) /Backwards (2)
2. Run Sideways (3)
3. Jump with both feet
4. Jump from one foot to another

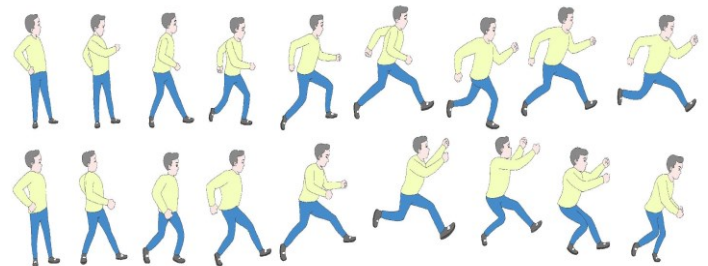

Variations:

1. Run on the spot slowly and quickly
2. Jump or move from one spot to another

Equipment:

1. Lime Powder
2. Cones & Markers

Activity 4: Animal Walk

Crab Walk

1. Begin by sitting on the floor with your feet hip-distance apart in front of you and your arms behind your back with fingers facing hips.
2. Lift hips off the floor and tighten your abs.
3. Start "walking" forward by moving your left hand followed by your right foot; and then your right hand followed by your left foot. Walk four or more steps as space allows, then walk back.
4. Continue back and forth for the desired amount of time.

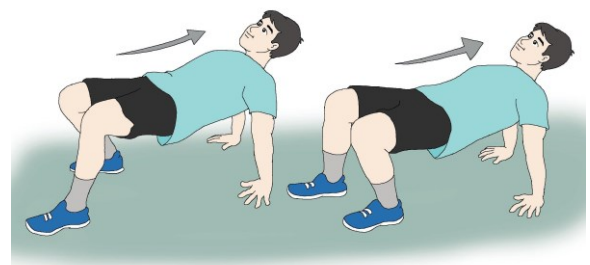

Bear Walk

1. Place your hands on the ground about 3 feet in front of you.
1. Keep your buttocks high in the air.
2. Step forward with one of your hands. Then step forward with the opposite foot. Step forward with the other arm and then the other foot.
3. Continue forward in the manner.
4. When you get to the end of the room you can either go backward or turn around and go the other direction.

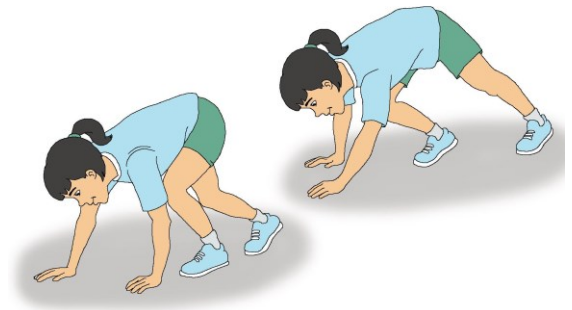

Snake Crawl

1. Go flat on your stomach.
2. As you crawl, rotate your knees out so your hips can hug the ground as close as possible.
3. Push the insides of your feet into the ground.



Donkey Kick

1. Get on all fours, with your hands stacked directly under shoulders, and knees under hips.
2. Make sure your back is flat (think: balancing a cup of coffee on your lower back), and tuck your chin slightly so the back of your neck is facing the ceiling.
3. Without rounding your spine, engage your lower abdominals. Keeping the 90-degree bend in your right knee, slowly lift your leg straight back and up toward the ceiling.
4. Your max height is right before your back starts to arch, or your hips begin to rotate.
5. Return to the starting position. Repeat all steps on one side, then switch legs.

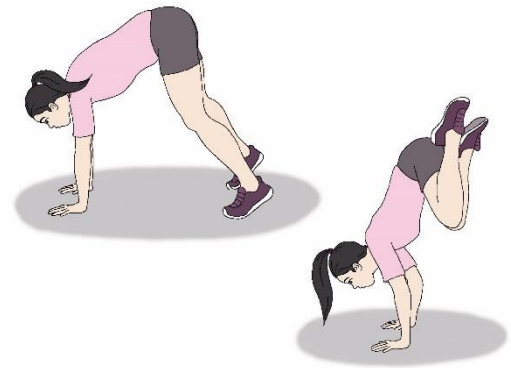

Activity 5: Static Balance: Standing like a Stork

1. Stand on one foot behind a sturdy chair, holding on for balance.
2. Hold position for up to 10 seconds.
3. Repeat 10-15 times.
4. Repeat 10-15 times with another leg.
5. Repeat 10-15 more times with each leg.

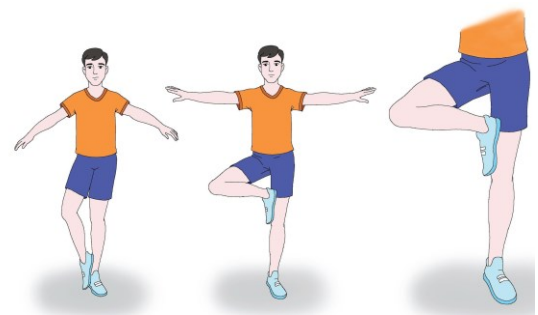

At the beginning you can hold the chair or wall for support.

As you progress try the balance activity without any support.

Activity 6: Skipping

1. Hold the jump rope in front of you with your hands together and your elbows close to your body.
2. Practice a toe catch.
3. Place the rope behind you and turn the jump rope over your head.
4. Catch the jump rope under your toes and lift up your heels and let it out from underneath your feet



Activity 7: Throwing and Catching

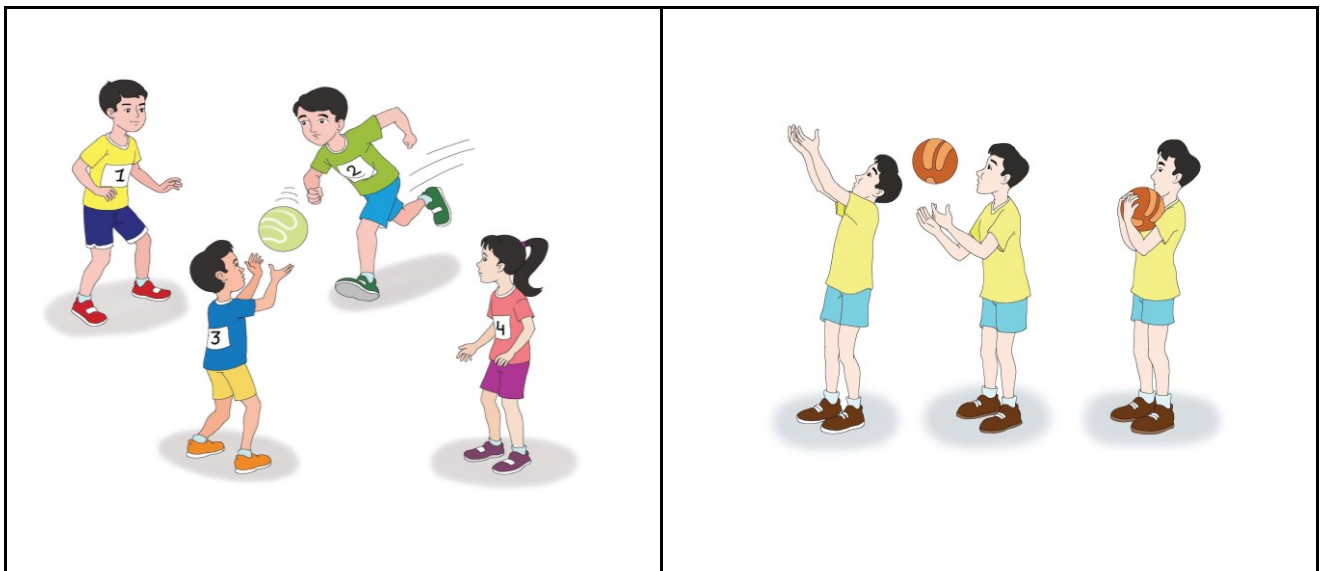

In the above activities there is a thrower who throws the ball towards the other person who is the catcher. This activity can be between two or more persons.

Activity 8: Zigzag Running

1. Place 5 cones in a zigzag pattern 3-5 feet apart.
2. Run quickly all the way around each cone and run diagonally to the next cone in 1 step.
3. Always go to the OUTSIDE of the cones and run all the way around.
4. Perform the drill down and walk back, then repeat for your second set. After 2 sets you'll take a 30 second break, then repeat for a total of 3 sets.

Activity 9: Jumping Jacks

1. Stand upright with your legs together, arms at your sides.
2. Bend your knees slightly, and jump into the air
3. As you jump, spread your legs to be about shoulder-width apart.
4. Stretch your arms out and over your head.
5. Jump back to the starting position. Repeat.

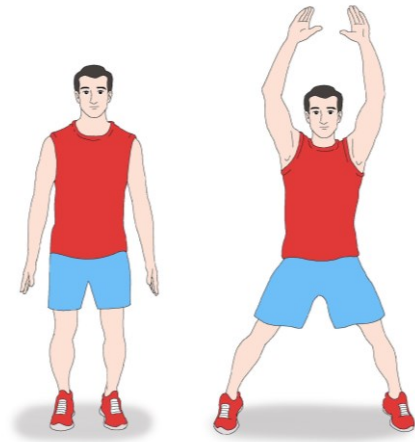

Activity 10: Shuttle Run

1. Place the cones the desired distance apart (usually 10 or 20 m).
2. Step 2: Place 2 small blocks or balls at the far cone.
3. Step 3: Start at the cone away from the blocks.
4. Step 4: Get into the sprinter position. Sprint as fast as you can to the other cone.
5. Step 5: Grab one of the blocks and immediately turn around and sprint back to the starting cone.
6. Step 6: Set the block at the starting cone and then sprint back to grab the second block.
7. Step 7: Grab the second block and turn and sprint through the starting cone.
8. Step 8: The time stops as soon as you pass the first cone for the final time.

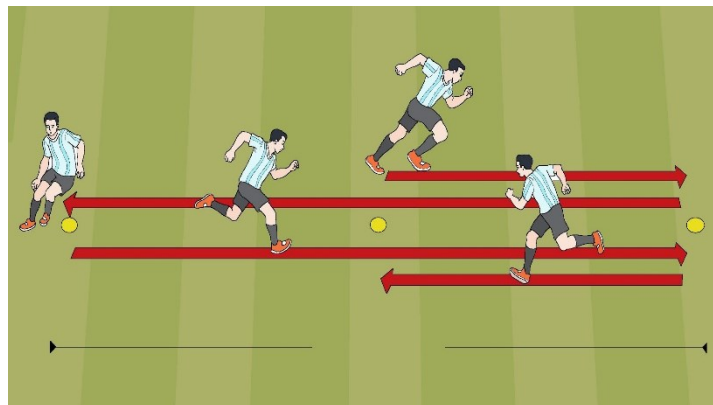

Activity 11: Stretching

Cat & Cow Pose

1. Start on all fours with the spine and neck in a neutral position. The back should be flat like a tabletop.
2. Eyes should look straight down to the ground. Inhale, drop the belly down and slowly lift the neck and head up. This is the cow half of the pose—picture a cow's swayed back with bony hips.
3. Next, on an exhale, lift the belly and spine so the back is arched like a cat's. Eyes look toward the belly button.
4. Alternate 5 to 10 cat-cow stretches, then return to the neutral hands-and-knees position.

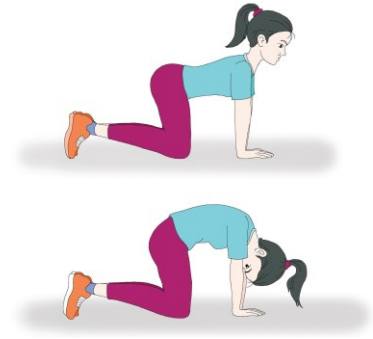

Overhead Arm Stretch

1. Stand up straight with feet together.
2. With back straight, reach arms straight up and overhead, without locking elbows.
3. Hands can be touching or apart. You can also do a very gentle backbend here. If you choose to bend backwards, keep your chin and neck lifted.



Shoulder Stretch

1. Reach the right arm straight out in front of you.
2. Bend the left arm and put the left wrist on the back of the right arm, just above the elbow.
3. Your left palm will be facing to the side.
4. Use the left arm to gently press the right arm across your body until you feel a good stretch. Hold for 10 to 30 seconds.
5. Switch arms and repeat.

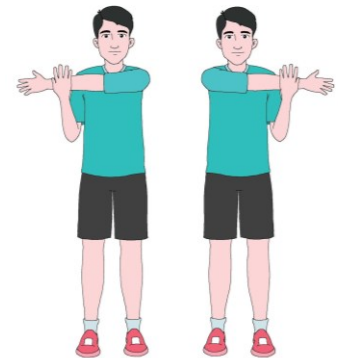

Butterfly Stretch:

1. In a seated position, place the soles of the feet together and hold them with the hands.
2. The legs are now forming the butterfly "wings." Elbows can be between the legs or resting on the knees.
3. Gently press the knees down to increase the stretch.
4. To add a spine stretch, bend forward from the upper back and reach forehead toward feet.



Activity 12: Chasing Games (Pakda Pakdi, Hide & Seek, Chain Chain, 7 Stones)

Tag Game (Pakda Pakdi):

1. One person is to touch someone else.
2. Decide who is "it." This person will chase the other players, trying to tag them, until he/she tags someone



Hide & Seek:

1. One person has to count till some number.
2. Then Other players will hide and just wait to be found.
3. The general idea is that one person is "it," that person closes his or her eyes and counts to a certain number without looking and then he or she tries to find the others.



Chain Chain:

1. Unlike most games which can be enjoyed in small groups, sakhli is the most fun in a group of more than five.
2. In this, when the 'denner' catches someone, the two must join hands and try to catch the others.
3. It's a challenge to run while catching one person's hand, but it gets really fun when three or more people are in the human chain!

7 Stones:

1. Children are divided into 2 teams.
2. A member of the one team tries to knock the stones with the help of a ball.
3. Once the stones are knocked down, the team must restore the stones.
4. The opposing team tries to stop them throwing the ball at the players.
5. If the ball touches any player, that player is out.
6. The team tries to rebuild the stones while managing to not get hit by the ball from the opposing team.

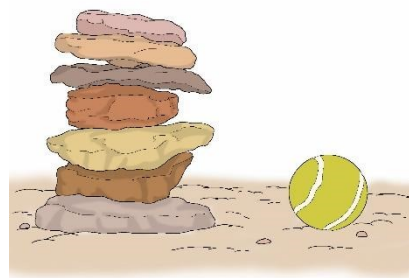

Activity 13: Relay Races (3 Legged Race, Lemon Race, Sack Race, Ball Carry)

3 Legged Race

1. Stand with your partner and face the same direction with your legs touching.
2. Tie the rope or cloth securely around the touching ankles.
3. Put your arm around your partner's waist, and have your partner do the same.
4. Put your untied leg behind the start line
5. Run in synchronization with your partner towards the finish line
6. Run, keeping your legs in sync.



Lemon & Spoon

1. Mark a start and finish line.
2. Line up the kids at the start line.
3. Give each child a spoon to hold in the mouth.
4. The lemon needs to be balanced on the spoon.
5. The one to reach the finish line first without dropping the lemon/ marble WINS



Sack Race

1. Each player puts both legs into the sack and hops around a cone, or some marked point, and back, tagging the next person in line.
2. Then, the next person in line gets into the sack and repeats the once-around the cone course.
3. The first team to the finish line wins.



Ball Carry

1. Stand face to face, hold two sticks and put the ball on the sticks.
2. The two children cooperate and carry the ball to the turning point and come back.
3. When you come back to the beginning point, you give the ball to the next two children and take turns.
4. If you drop the ball, pick it up and start again from the children who dropped it.

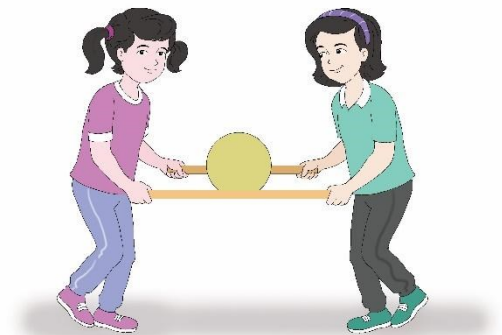

4.2 Activities for Age 9-18 years (Class IV to XII) - Focus on Sports Skills Development

Games-related concepts are introduced to Children through modified games at the upper primary and reinforced at the secondary levels. Both fundamental and specialised skills and movement concepts are required in playing these games. In this syllabus, games are classified into the following categories:

1. Net-barrier
2. Striking-fielding
3. Territorial-invasion

Within each game category, there are games-related concepts that are transferable across games within the same category. Game-specific skills are also identified for selected games for the learning area of Physical Activities.

Apart from good balance and stability, the fitness aspects that needs to be developed during this phase are:

1. Muscular Strength and Muscular Endurance
2. Speed
3. Flexibility
4. Cardio-vascular Endurance

4.3 Suggested Fitness Exercises for Age 9-14 (Class 4-8)

Fit India recommends the following activities for improvement of fitness for the 9-14 age groups:

4.3.1 Endurance related Activities

1. **Spot Running (improves Speed & Endurance & Core Strength)**

- a. Stand straight.
- b. Start jogging.
- c. Make sure to jump on toes and land on your heels.
- d. As this is a warm-up, do this for 30 to 45 seconds.

2. **Climbing Stairs (Endurance)**

- a. Step the right foot onto the first step, followed by the left.
- b. Continue this stepping motion until you've reached the top of the stairs.
- c. Always lead with the high foot.
- d. Don't let your feet cross while climbing up the stairs.

3. **Walking on toes (Endurance)**

- a. Position the heel of one foot just in front of the toes of the other foot. Your heel and toes should touch or almost touch.
- b. Choose a spot ahead of you and focus on it to keep you steady as you walk.
- c. Take a step.
- d. Put your heel just in front of the toe of your other foot.
- e. Repeat for 20 steps.

4. **Swimming (Endurance)**

- a. Float with your face in the water, your body straight and horizontal.

- b. Stack your hands and keep your arms and legs long.
- c. Kick out and back in a circle then snap your feet together.
- d. Drop your head underwater and exhale.

5. Jumping Jacks (Endurance)

- a. Jump up and spread your legs apart as you swing your arms over your head.
- b. Jump again and bring your arms back to your sides and your legs together.

6. March and Swing Your Arms (Endurance)

- a. March in place. Lift your knees up as high as you can. Go at a steady pace.
- b. As you bring your knee up, swing the opposite arm in front of you.
- c. Switch your arms when you switch your legs

4.3.2 Strength related Activities

1. Straight Leg Raises (Strength)

- a. Stand tall. Use a chair or wall for balance.
- b. Forward:
 - i. Slowly lift your leg up in front of you as high as you can.
 - ii. Keep your leg straight.
 - iii. Then lower back to the starting position.
 - iv. Do not relax your leg.
 - v. Do not swing your leg.
- c. Side:
 - i. Slowly lift your leg out to the side with your toe pointed forward.
 - ii. Keep your leg straight.
 - iii. Then lower back to the starting position.
 - iv. Do not relax your leg.
 - v. Do not swing your leg.
- d. After you have completed all leg lifts on one side, switch to the other side.

2. Push Ups on the Wall (Strength)

- a. Stand facing the wall.
- b. Place your hands flat on the wall at shoulder level.
- c. Keep your arms straight.
- d. Your feet should be behind your body so that you are leaning on the wall.
- e. Stand on the balls of your feet.
- f. Bend your arms to bring your chest to the wall.

- g. Keep your legs in place.
- h. Make your body a straight line.
 - i. Push your arms straight to return to the starting position.
 - j. Make sure your body stays in a straight line the whole time.

3. Long Jump (Strength)

Goal starts from the same point on the track and always is running at full speed when the takeoff foot hits the board.

4. Goal Keeping (Strength)

Goalkeeper is the last line of defense who needs to guard his goal and protect his team.

4.3.3 Flexibility related Activities

1. Calf Stretch

- a. Stand facing a wall. Put your hands against the wall at shoulder height.
- b. Put one foot in front of the other.
- c. Bend your elbows and lean in toward the wall. You will feel a stretch in your calves.
- d. Keep your knee straight and your hips forward. Make sure your heel stays on the ground.
Switch your feet and repeat the stretch.

2. Child's Pose

- a. Kneel on the ground.
- b. Bend at your hips. Put your arms next to your head with your hands on the ground in front of you.
- c. Sit your bottom down over your heels. You should feel a stretch in your shoulders and lower back.

3. Knee to Chest

- a. Lie on your back with your legs straight.
- b. Bring the right knee toward your chest.
- c. Wrap your arms underneath your knee and pull your leg closer to your body until you feel a stretch in the back of your right thigh.
- d. Repeat the stretch on your left leg.

4. Bend Down (Flexibility)

- a. Stand tall with your feet hip-width apart, knees slightly bent, arms by your sides.

- b. Exhale as you bend forward at the hips, lowering your head toward the floor, while keeping your head, neck and shoulders relaxed.

4.3.4 Balance related Activities

1. Single Leg Stance

- a. Stand on one leg with your arms out to the side.
- b. Work up to holding this position for 30 seconds.

2. Leg Swings

- a. Stand on one leg, swinging the other leg front to back.
- b. You can lightly hold onto something for help if necessary.
- c. Do 10 swings on each side.

3. Walking on Lines of different Shapes

- a. Find or make a straight/zigzag line on the floor.
- b. Walk on the line for 20 steps.
- c. You can put your arms out to the side for additional balance help.

4.4 Suggested Fitness Activities for age 15-18 (Class 9-12)

Fit India recommends the following activities for improvement of fitness for the 15-18 age groups:

4.4.1 Endurance and speed related Activities

1. 800 m Race (Endurance)

- a. Do this as a group activity with many children
- b. Try to complete a given task in the shortest amount of time.

2. Brisk Walking (Endurance)

- a. Walk a little initially and then gradually increase the time.
- b. Take light, easy steps and make sure your heel touches down before your toes.

3. Quick Air Punches (Endurance)

- a. Push off with your back foot and set foot, Quarter-rotate your jabbing shoulder as you throw the punch, fist your palm and punch.

4. 4*100/200/400 m Relay Race (Endurance & speed)

- a. The first runner holds the baton in the right hand, the second runner will receive the baton – and will run with it – in the left hand, the third will receive and carry the baton in the right hand and the final runner will handle it in the left hand.

5. Swimming (Cardio Endurance)

- a. Float with your face in the water, your body straight and horizontal.
- b. Stack your hands and keep your arms and legs long.
- c. Kick out and back in a circle then snap your feet together.
- d. Drop your head underwater and exhale.

6. Walking lunges (Muscular Endurance)

- a. Stand tall in front of a long and clear walkway.
- b. Your feet should be hip-width apart, your chest up, and your core and glutes engaged.
- c. Take a big step forwards with your left foot, lowering until both your knees are bent at 90° and your front thigh is parallel to the floor.

4.4.2 Strength related Activities

1. Curl Up (core strength)

- a. Lie on your back on the floor. Bend your hips and knees so your feet are flat on the floor. Reach your arms toward your knees.
- b. Lift your head, and then slowly lift your upper back until your hands reach your knees.
- c. Try to get your shoulder blades completely off the ground.
- d. Pause and then slowly lower all the way back down, including your head.

2. Plank (core strength)

- a. Assume a modified push-up position with your elbows bent 90 degrees and both forearms resting on the floor.
- b. Position your elbows directly underneath your shoulders and look straight toward the floor.
- c. Your body should form a perfectly straight line from the crown of your head to your heels

3. Push ups (upper body strength)

- a. Keep your feet together.
- b. Your weight should be on your chest.
- c. Position hands palms-down on the floor

- d. Raise your body by using your arms

4. Squat (lower body strength)

- a. Plant your feet on the ground
- b. Bend your knees
- c. Lower yourself in a controlled manner.

4.4.3 Flexibility related Activities

1. Forward Bend (flexibility)

- a. Stand with your feet together, extend your torso down without rounding your back.
- b. Stay long throughout your neck, extending the crown of your head toward the ground.
- c. Draw your shoulders down your back.



5. Age-appropriate Yoga Protocols

Yoga has the ability to change our perspectives of life. More keenness for life, genuine and natural sense of feel good, renewed sense of health and wellbeing are some of the benefits of Yoga. It's therapeutic approaches and principles represent the essence of a broad holistic dimension to health and disease. The practice of Yoga facilitates mind and body coordination, emotional equanimity, intellectual clarity to the practitioners. For children in the age group of 5-8 years (Class 1-3), 9-14 years (Class 4-8) and 14-18 Years (Class 9-12), the following Yoga Protocols are to be followed:

5.1 Yoga protocol for Age of 5-8 Years (Class 1-3)

Sequence	Yoga practices	Rounds	Duration
1.	Prayer		1 min
2.	Loosening Practices	2 rounds	3 mins
	Neck Movement Left and Right (Road crossing movement) Neck Movement Up and Down (Watch sky & earth) Shoulder rotation (Clock and anti-clock wise) Back Twisting Movement (Pass the ball to other) Side Bending (See-saw movement)		
3.	Yogasanas	2 rounds	8 mins
Standing	Tadasana (The Palm tree pose)		
	Trikonasana (The Triangle pose)		
Sitting	Parvatasana (The Mountain pose)		
	Marjariasana (The Cat pose)		
	Simhasana (The Roaring lion pose)		
Prone	SaralBhujangasana (The Cobra pose)		
	Balasana (The Child Pose)		
Supine	Shavasana (The Star fish pose)		
4.	Pranayama	2 rounds	2 mins
	<ul style="list-style-type: none"> Bhramari Pranayama (Humming) 		
5.	Krida Practice		2 min
	<ul style="list-style-type: none"> Laughing 		
TOTAL DURATION			15 Mins

Important Guidelines for Children:

- ✓ Children less than 6 years of age should not stay for more than 10 seconds in the final stage of any Asana.
- ✓ The total duration for kid's Yoga session should not be more than 20 minutes.
- ✓ Children are advised not to do breath holding practices.

- ✓ Avoid extreme forward and backward bending asanas.
- ✓ If the child complains of any discomfort while practicing Yoga, may seek medical help.

5.2 Yoga protocol for Age of 9-18 Years(Class 4-12)

Sequence	Yoga practices	Rounds	Duration
1.	Prayer		1 min
2.	Surya Namaskar	2 rounds	2 mins
3.	Yogasanas	2 rounds	8 mins
Standing	Tadasana (The Palm tree pose)		
	Katicakrasana (The Trunk twisting)		
	Trikonasana (The Triangle pose)		
Sitting	Ushtrasana (The Camel pose)		
	Paschimottanasana (Seated forward bend)		
	Ardha-Matsyendrasana (Half Spinal twist)		
Prone	Dhanurasana (The Bow pose)		
	Makarasana (The Crocodile pose)		
Supine	Ardha-Halsana (90 degree leg raise)		
	Pavanamuktasana (The Wind releasing pose)		
	Shavasana (The Corpse Pose)		
4.	Pranayama	2 rounds	2 mins
	<ul style="list-style-type: none"> ● Bhramari Pranayama (Humming) 		
5.	Dhyana		2 mins
	<ul style="list-style-type: none"> ● Focus on your Breath 		
TOTAL DURATION			15 Minutes

To know about each of the Yoga Protocols, please refer to Ministry of AYUSH Website:

<http://ayush.gov.in/genericcontent/common-yoga-protocol-2017>

Yoga Protocols Videos (in different languages):

https://www.youtube.com/playlist?list=PLRR-Y7wX83ktZnITgjRzI9v_8BaYRMDf-



6. Guidelines & Safety Considerations

6.1 Environmental Consideration

- a. Adequate precautionary measures related to adequate hydration and proper clothing should be taken before undertaking physical exercises in hot humid, cold & high altitude areas.
- b. Adequate rest, quality sleep, Nutrition & Hydration status be ensured before undertaking exercise protocol as an essential safety prerequisite.
- c. Sustained and heavy exercises are to be avoided in Hot & Humid environment.
- d. Appropriate modification should be carried out in exercise protocols keeping in view of the prevailing local environmental conditions be undertaken (extreme weather conditions).

6.2 Warm up

- a. Warm-up for a duration of 5-10 minutes will be an integral part of the exercise protocol.
- b. Light Stretching be undertaken as a part of the warm up phase of exercise protocol which has a role in injury prevention.

6.3 Hydration

- a. Appropriate measures should be undertaken during the duration of exercise to maintain adequate hydration to make up for the loss of fluid & electrolyte (water and salt) during exercise.

6.4 Cool Down

- a. Cooling down by undertaking light aerobic exercises & stretching of major joints for a duration of 5-10 minutes be undertaken after the end of the exercise.

6.5 Other Considerations

- a. Participants across the age group having a Body Mass Index (BMI) more than 30 are advised to start the exercise protocol in a gradual manner with relatively lesser time duration, lower intensity & lesser frequency and be encouraged to gradually increase the frequency, time & intensity till it is tolerated well.
- b. Children with known medical history should exercise under supervision, after due clearance from concerned Medical Practitioners.

Participants are encouraged to be vigilant about the possible development / occurrence of symptoms with regard to adverse medical conditions and immediately stop the exercise and seek medical attention.



7. Benchmarks for Fitness Tests

7.1 Description of Fitness Indicators

	L1 (Work Harder)	L2 (Must Improve)	L3 (Can do Better)	L4 (Good)	L5 (Very Good)	L6 (Athletic)	L7 (Sports Fit)
Level	Level 1	Level 2	Level 3	Level 4	Level 5	Level 6	Level 7
Score	2 Points	4 Points	6 Points	7 Points	8 Points	9 Points	10 Points

The following Khelo India Battery of Fitness Assessment Tests and the Benchmark Levels were finalised by an Expert Committee set up by the Ministry of Youth Affairs and Sports.

The following benchmarks are the baseline reference point for current Academic Year (2020-21). At the end of the Academic Year, the Fitness benchmarks will be generated based on the fitness assessment being done in school across India.

For the purpose of current year's reference point, the following benchmarks are to be used:

7.2 Coordination Test - Plate Tapping for Boys

Age	L1 (Work Harder)	L2 (Must Improve)	L3 (Can do Better)	L4 (Good)	L5 (Very Good)	L6 (Athletic)	L7 (Sports Fit)
5	< 00 m 25 s 250 ms to 00 m 19 s 290 ms	< 00 m 19 s 290 ms to 00 m 16 s 700 ms	< 00 m 16 s 700 ms to 00 m 15 s 60 ms	< 00 m 15 s 60 ms to 00 m 14 s 340 ms	< 00 m 14 s 340 ms to 00 m 13 s 600 ms	< 00 m 13 s 600 ms to 00 m 12 s 720 ms	< 00 m 12 s 720 ms
6	< 00 m 21 s 550 ms to 00 m 18 s 190 ms	< 00 m 18 s 190 ms to 00 m 16 s 310 ms	< 00 m 16 s 310 ms to 00 m 14 s 970 ms	< 00 m 14 s 970 ms to 00 m 14 s 330 ms	< 00 m 14 s 330 ms to 00 m 13 s 650 ms	< 00 m 13 s 650 ms to 00 m 12 s 800 ms	< 00 m 12 s 800 ms
7	< 00 m 19 s 480 ms to 00 m 16 s 680 ms	< 00 m 16 s 680 ms to 00 m 15 s 70 ms	< 00 m 15 s 70 ms to 00 m 13 s 900 ms	< 00 m 13 s 900 ms to 00 m 13 s 350 ms	< 00 m 13 s 350 ms to 00 m 12 s 750 ms	< 00 m 12 s 750 ms to 00 m 12 s 0 ms	< 00 m 12 s 0 ms
8	< 00 m 17 s 310 ms to 00 m 15 s 510 ms	< 00 m 15 s 510 ms to 00 m 14 s 100 ms	< 00 m 14 s 100 ms to 00 m 13 s 70 ms	< 00 m 13 s 70 ms to 00 m 12 s 580 ms	< 00 m 12 s 580 ms to 00 m 12 s 50 ms	< 00 m 12 s 50 ms to 00 m 11 s 370 ms	< 00 m 11 s 370 ms

7.3 Coordination Test - Plate Tapping for Girls

Age	L1 (Work Harder)	L2 (Must Improve)	L3 (Can do Better)	L4 (Good)	L5 (Very Good)	L6 (Athletic)	L7 (Sports Fit)
5	< 00 m 25 s	< 00 m 19 s	< 00 m 16 s	< 00 m 15 s	< 00 m 14 s	< 00 m 13 s	< 00 m 12 s

	250 ms to 00 m 19 s 290 ms	290 ms to 00 m 16 s 700 ms	700 ms to 00 m 15 s 60 ms	60 ms to 00 m 14 s 340 ms	340 ms to 00 m 13 s 600 ms	600 ms to 00 m 12 s 720 ms	720 ms
6	< 00 m 22 s 350 ms to 00 m 17 s 770 ms	< 00 m 17 s 770 ms to 00 m 15 s 640 ms	< 00 m 15 s 640 ms to 00 m 14 s 250 ms	< 00 m 14 s 250 ms to 00 m 13 s 620 ms	< 00 m 13 s 620 ms to 00 m 12 s 970 ms	< 00 m 12 s 970 ms to 00 m 12 s 190 ms	< 00 m 12 s 190 ms
7	< 00 m 19 s 930 ms to 00 m 16 s 380 ms	< 00 m 16 s 380 ms to 00 m 14 s 630 ms	< 00 m 14 s 630 ms to 00 m 13 s 450 ms	< 00 m 13 s 450 ms to 00 m 12 s 910 ms	< 00 m 12 s 910 ms to 00 m 12 s 350 ms	< 00 m 12 s 350 ms to 00 m 11 s 660 ms	< 00 m 11 s 660 ms
8	< 00 m 18 s 410 ms to 00 m 15 s 530 ms	< 00 m 15 s 530 ms to 00 m 14 s 40 ms	< 00 m 14 s 40 ms to 00 m 13 s 10 ms	< 00 m 13 s 10 ms to 00 m 12 s 530 ms	< 00 m 12 s 530 ms to 00 m 12 s 30 ms	< 00 m 12 s 30 ms to 00 m 11 s 410 ms	< 00 m 11 s 410 ms

7.4 Balance Test - Flamingo Balance Test Boys

Age	L1 (Work Harder)	L2 (Must Improve)	L3 (Can do Better)	L4 (Good)	L5 (Very Good)	L6 (Athletic)	L7 (Sports Fit)
5	< 24 times to 18 times	< 18 times to 13 times	< 13 times to 10 times	< 10 times to 9 times	< 9 times to 7 times	< 7 times to 5 times	< 5 times
6	< 25 times to 18 times	< 18 times to 14 times	< 14 times to 10 times	< 10 times to 8 times	< 8 times to 7 times	< 7 times to 5 times	< 5 times
7	< 26 times to 18 times	< 18 times to 14 times	< 14 times to 10 times	< 10 times to 8 times	< 8 times to 7 times	< 7 times to 4 times	< 4 times
8	< 26 times to 18 times	< 18 times to 14 times	< 14 times to 10 times	< 10 times to 8 times	< 8 times to 7 times	< 7 times to 5 times	< 5 times

7.5 Balance Test - Flamingo Balance Test Girls

Age	L1 (Work Harder)	L2 (Must Improve)	L3 (Can do Better)	L4 (Good)	L5 (Very Good)	L6 (Athletic)	L7 (Sports Fit)
5	< 23 times to 17 times	< 17 times to 13 times	< 13 times to 10 times	< 10 times to 8 times	< 8 times to 7 times	< 7 times to 5 times	< 5 times
6	< 23 times to 17 times	< 17 times to 13 times	< 13 times to 10 times	< 10 times to 8 times	< 8 times to 7 times	< 7 times to 5 times	< 5 times
7	< 23 times to 17 times	< 17 times to 13 times	< 13 times to 10 times	< 10 times to 8 times	< 8 times to 7 times	< 7 times to 5 times	< 5 times
8	< 24 times to 17 times	< 17 times to 13 times	< 13 times to 10 times	< 10 times to 8 times	< 8 times to 7 times	< 7 times to 5 times	< 5 times

7.6 Abdominal/Core strength - Partial Curl-up for Boys

Age	L1 (Work Harder)	L2 (Must Improve)	L3 (Can do Better)	L4 (Good)	L5 (Very Good)	L6 (Athletic)	L7 (Sports Fit)
9	> 9 times to 13 times	> 13 times to 13 times	> 13 times to 18 times	> 18 times to 20 times	> 20 times to 21 times	> 21 times to 23 times	> 23 times
10	> 11 times to	> 15 times to	> 15 times to	> 20 times to	> 22 times to	> 23 times to	> 25 times

	15 times	15 times	20 times	22 times	23 times	25 times	
11	> 13 times to 16 times	> 16 times to 16 times	> 16 times to 22 times	> 22 times to 23 times	> 23 times to 24 times	> 24 times to 26 times	> 26 times
12	> 14 times to 16 times	> 16 times to 16 times	> 16 times to 22 times	> 22 times to 24 times	> 24 times to 25 times	> 25 times to 27 times	> 27 times
13	> 14 times to 18 times	> 18 times to 18 times	> 18 times to 23 times	> 23 times to 24 times	> 24 times to 26 times	> 26 times to 28 times	> 28 times
14	> 15 times to 19 times	> 19 times to 19 times	> 19 times to 24 times	> 24 times to 25 times	> 25 times to 27 times	> 27 times to 29 times	> 29 times
15	> 17 times to 20 times	> 20 times to 20 times	> 20 times to 25 times	> 25 times to 26 times	> 26 times to 28 times	> 28 times to 30 times	> 30 times
16	> 18 times to 20 times	> 20 times to 20 times	> 20 times to 26 times	> 26 times to 27 times	> 27 times to 29 times	> 29 times to 30 times	> 30 times
17	> 18 times to 22 times	> 22 times to 22 times	> 22 times to 27 times	> 27 times to 28 times	> 28 times to 29 times	> 29 times to 31 times	> 31 times
18	> 18 times to 21 times	> 21 times to 21 times	> 21 times to 28 times	> 28 times to 29 times	> 29 times to 30 times	> 30 times to 31 times	> 31 times

7.8 Abdominal/Core strength - Partial Curl-up for Girls

Age	L1 (Work Harder)	L2 (Must Improve)	L3 (Can do Better)	L4 (Good)	L5 (Very Good)	L6 (Athletic)	L7 (Sports Fit)
9	> 9 times to 13 times	> 13 times to 13 times	> 13 times to 18 times	> 18 times to 19 times	> 19 times to 21 times	> 21 times to 23 times	> 23 times
10	> 10 times to 14 times	> 14 times to 14 times	> 14 times to 19 times	> 19 times to 20 times	> 20 times to 22 times	> 22 times to 24 times	> 24 times
11	> 11 times to 15 times	> 15 times to 15 times	> 15 times to 20 times	> 20 times to 21 times	> 21 times to 22 times	> 22 times to 24 times	> 24 times
12	> 12 times to 15 times	> 15 times to 15 times	> 15 times to 20 times	> 20 times to 21 times	> 21 times to 23 times	> 23 times to 24 times	> 24 times
13	> 12 times to 15 times	> 15 times to 15 times	> 15 times to 20 times	> 20 times to 21 times	> 21 times to 23 times	> 23 times to 24 times	> 24 times
14	> 12 times to 16 times	> 16 times to 16 times	> 16 times to 20 times	> 20 times to 21 times	> 21 times to 23 times	> 23 times to 24 times	> 24 times
15	> 13 times to 16 times	> 16 times to 16 times	> 16 times to 21 times	> 21 times to 22 times	> 22 times to 23 times	> 23 times to 25 times	> 25 times
16	> 13 times to 16 times	> 16 times to 16 times	> 16 times to 21 times	> 21 times to 22 times	> 22 times to 23 times	> 23 times to 25 times	> 25 times
17	> 13 times to 17 times	> 17 times to 17 times	> 17 times to 21 times	> 21 times to 22 times	> 22 times to 23 times	> 23 times to 25 times	> 25 times
18	> 14 times to 16 times	> 16 times to 16 times	> 16 times to 21 times	> 21 times to 22 times	> 22 times to 24 times	> 24 times to 25 times	> 25 times

7.9 Muscular Endurance - Push-ups for Boys

Age	L1 (Work Harder)	L2 (Must Improve)	L3 (Can do Better)	L4 (Good)	L5 (Very Good)	L6 (Athletic)	L7 (Sports Fit)
9	> 4 times to	> 5 times to	> 6 times to	> 7 times to	> 8 times to	> 9 times to	> 10 times

	5 times	6 times	7 times	8 times	9 times	10 times	
10	> 5 times to 6 times	> 6 times to 7 times	> 7 times to 8 times	> 8 times to 9 times	> 9 times to 10 times	> 10 times to 11 times	> 11 times
11	> 6 times to 7 times	> 7 times to 8 times	> 8 times to 9 times	> 9 times to 10 times	> 10 times to 11 times	> 11 times to 13 times	> 13 times
12	> 7 times to 8 times	> 8 times to 9 times	> 9 times to 10 times	> 10 times to 11 times	> 11 times to 13 times	> 13 times to 15 times	> 15 times
13	> 8 times to 9 times	> 9 times to 10 times	> 10 times to 11 times	> 11 times to 13 times	> 13 times to 15 times	> 15 times to 16 times	> 16 times
14	> 9 times to 10 times	> 10 times to 11 times	> 11 times to 13 times	> 13 times to 15 times	> 15 times to 16 times	> 16 times to 17 times	> 17 times
15	> 13 times to 15 times	> 15 times to 17 times	> 17 times to 19 times	> 19 times to 21 times	> 21 times to 23 times	> 23 times to 28 times	> 28 times
16	> 15 times to 17 times	> 17 times to 19 times	> 19 times to 21 times	> 21 times to 23 times	> 23 times to 28 times	> 28 times to 33 times	> 33 times
17	> 17 times to 19 times	> 19 times to 21 times	> 21 times to 23 times	> 23 times to 28 times	> 28 times to 33 times	> 33 times to 37 times	> 37 times
18	> 19 times to 21 times	> 21 times to 23 times	> 23 times to 28 times	> 28 times to 33 times	> 33 times to 37 times	> 37 times to 43 times	> 43 times

7.10 Muscular Endurance - Modified Push-ups for Girls

Age	L1 (Work Harder)	L2 (Must Improve)	L3 (Can do Better)	L4 (Good)	L5 (Very Good)	L6 (Athletic)	L7 (Sports Fit)
9	> 3 times to 4 times	> 4 times to 6 times	> 6 times to 7 times	> 7 times to 7 times	> 7 times to 8 times	> 8 times to 8 times	> 8 times
10	> 4 times to 6 times	> 6 times to 7 times	> 7 times to 7 times	> 7 times to 8 times	> 8 times to 8 times	> 8 times to 9 times	> 9 times
11	> 6 times to 7 times	> 7 times to 7 times	> 7 times to 8 times	> 8 times to 8 times	> 8 times to 9 times	> 9 times to 10 times	> 10 times
12	> 7 times to 7 times	> 7 times to 8 times	> 8 times to 8 times	> 8 times to 9 times	> 9 times to 10 times	> 10 times to 12 times	> 12 times
13	> 7 times to 8 times	> 8 times to 8 times	> 8 times to 9 times	> 9 times to 10 times	> 10 times to 12 times	> 12 times to 14 times	> 14 times
14	> 10 times to 11 times	> 11 times to 13 times	> 13 times to 15 times	> 15 times to 16 times	> 16 times to 17 times	> 17 times to 19 times	> 19 times
15	> 11 times to 13 times	> 13 times to 15 times	> 15 times to 16 times	> 16 times to 17 times	> 17 times to 19 times	> 19 times to 21 times	> 21 times
16	> 13 times to 15 times	> 15 times to 16 times	> 16 times to 17 times	> 17 times to 19 times	> 19 times to 21 times	> 21 times to 22 times	> 22 times
17	> 15 times to 16 times	> 16 times to 17 times	> 17 times to 19 times	> 19 times to 21 times	> 21 times to 22 times	> 22 times to 24 times	> 24 times
18	> 16 times to 17 times	> 17 times to 19 times	> 19 times to 21 times	> 21 times to 22 times	> 22 times to 24 times	> 24 times to 27 times	> 27 times

7.11 Flexibility Test - Sit and Reach for Boys (9-18 years)

Age	L1 (Work Harder)	L2 (Must Improve)	L3 (Can do Better)	L4 (Good)	L5 (Very Good)	L6 (Athletic)	L7 (Sports Fit)
-----	------------------	-------------------	--------------------	-----------	----------------	---------------	-----------------

	Harder)	Improve)	Better)		Good)		Fit)
9	> 6.00 cm to 10.70 cm	> 10.70 cm to 14.40 cm	> 14.40 cm to 17.60 cm	> 17.60 cm to 19.40 cm	> 19.40 cm to 21.40 cm	> 21.40 cm to 26.80 cm	> 26.80 cm
10	> 6.00 cm to 10.80 cm	> 10.80 cm to 14.40 cm	> 14.40 cm to 17.70 cm	> 17.70 cm to 19.40 cm	> 19.40 cm to 21.50 cm	> 21.50 cm to 26.90 cm	> 26.90 cm
11	> 6.00 cm to 10.80 cm	> 10.80 cm to 14.40 cm	> 14.40 cm to 17.70 cm	> 17.70 cm to 19.40 cm	> 19.40 cm to 21.50 cm	> 21.50 cm to 26.90 cm	> 26.90 cm
12	> 6.00 cm to 10.80 cm	> 10.80 cm to 14.50 cm	> 14.50 cm to 17.80 cm	> 17.80 cm to 19.60 cm	> 19.60 cm to 21.70 cm	> 21.70 cm to 27.10 cm	> 27.10 cm
13	> 6.10 cm to 11.10 cm	> 11.10 cm to 14.80 cm	> 14.80 cm to 18.20 cm	> 18.20 cm to 20.00 cm	> 20.00 cm to 22.20 cm	> 22.20 cm to 27.70 cm	> 27.70 cm
14	> 6.70 cm to 12.10 cm	> 12.10 cm to 16.20 cm	> 16.20 cm to 19.90 cm	> 19.90 cm to 21.90 cm	> 21.90 cm to 24.20 cm	> 24.20 cm to 30.30 cm	> 30.30 cm
15	> 7.70 cm to 13.70 cm	> 13.70 cm to 18.30 cm	> 18.30 cm to 22.40 cm	> 22.40 cm to 24.60 cm	> 24.60 cm to 27.20 cm	> 27.20 cm to 34.00 cm	> 34.00 cm
16	> 8.40 cm to 14.60 cm	> 14.60 cm to 19.30 cm	> 19.30 cm to 23.60 cm	> 23.60 cm to 25.90 cm	> 25.90 cm to 28.60 cm	> 28.60 cm to 35.60 cm	> 35.60 cm
17	> 9.10 cm to 15.50 cm	> 15.50 cm to 20.40 cm	> 20.40 cm to 24.80 cm	> 24.80 cm to 27.20 cm	> 27.20 cm to 30.00 cm	> 30.00 cm to 37.20 cm	> 37.20 cm
18	> 9.10 cm to 15.50 cm	> 15.50 cm to 19.30 cm	> 19.30 cm to 24.80 cm	> 24.80 cm to 27.30 cm	> 27.30 cm to 30.20 cm	> 30.20 cm to 37.40 cm	> 37.40 cm

7.12 Flexibility Test - Sit and Reach for Girls (9-18 years)

Age	L1 (Work Harder)	L2 (Must Improve)	L3 (Can do Better)	L4 (Good)	L5 (Very Good)	L6 (Athletic)	L7 (Sports Fit)
9	> 7.90 cm to 13.10 cm	> 13.10 cm to 16.90 cm	> 16.90 cm to 20.30 cm	> 20.30 cm to 22.10 cm	> 22.10 cm to 24.20 cm	> 24.20 cm to 29.60 cm	> 29.60 cm
10	> 8.50 cm to 13.70 cm	> 13.70 cm to 17.50 cm	> 17.50 cm to 20.90 cm	> 20.90 cm to 22.70 cm	> 22.70 cm to 24.80 cm	> 24.80 cm to 30.10 cm	> 30.10 cm
11	> 9.40 cm to 14.50 cm	> 14.50 cm to 18.40 cm	> 18.40 cm to 21.70 cm	> 21.70 cm to 23.50 cm	> 23.50 cm to 25.60 cm	> 25.60 cm to 31.00 cm	> 31.00 cm
12	> 10.60 cm to 15.80 cm	> 15.80 cm to 19.70 cm	> 19.70 cm to 23.10 cm	> 23.10 cm to 24.90 cm	> 24.90 cm to 27.10 cm	> 27.10 cm to 32.50 cm	> 32.50 cm
13	> 11.90 cm to 17.30 cm	> 17.30 cm to 21.30 cm	> 21.30 cm to 24.80 cm	> 24.80 cm to 26.70 cm	> 26.70 cm to 28.90 cm	> 28.90 cm to 34.40 cm	> 34.40 cm
14	> 13.10 cm to 18.60 cm	> 18.60 cm to 22.70 cm	> 22.70 cm to 26.30 cm	> 26.30 cm to 28.20 cm	> 28.20 cm to 30.40 cm	> 30.40 cm to 36.10 cm	> 36.10 cm
15	> 13.90 cm to 19.50 cm	> 19.50 cm to 23.60 cm	> 23.60 cm to 27.20 cm	> 27.20 cm to 29.10 cm	> 29.10 cm to 31.30 cm	> 31.30 cm to 37.00 cm	> 37.00 cm
16	> 14.40 cm to 20.00 cm	> 20.00 cm to 24.10 cm	> 24.10 cm to 27.60 cm	> 27.60 cm to 29.50 cm	> 29.50 cm to 31.80 cm	> 31.80 cm to 37.50 cm	> 37.50 cm
17	> 14.70 cm to 20.30 cm	> 20.30 cm to 24.40 cm	> 24.40 cm to 27.90 cm	> 27.90 cm to 29.80 cm	> 29.80 cm to 32.10 cm	> 32.10 cm to 37.80 cm	> 37.80 cm
18	> 14.90 cm to 20.70 cm	> 20.70 cm to 24.70 cm	> 24.70 cm to 28.20 cm	> 28.20 cm to 30.00 cm	> 30.00 cm to 32.30 cm	> 32.30 cm to 38.00 cm	> 38.00 cm

7.13 Cardiovascular Endurance - 600 m Run/Walk - Boys

Age	L1 (Work Harder)	L2 (Must Improve)	L3 (Can do Better)	L4 (Good)	L5 (Very Good)	L6 (Athletic)	L7 (Sports Fit)
9	< 03 m 30 s 0 ms to 03 m 24 s 600 ms	< 03 m 24 s 600 ms to 03 m 20 s 400 ms	< 03 m 20 s 400 ms to 03 m 17 s 400 ms	< 03 m 17 s 400 ms to 03 m 16 s 200 ms	< 03 m 16 s 200 ms to 03 m 15 s 600 ms	< 03 m 15 s 600 ms to 03 m 15 s 0 ms	< 03 m 15 s 0 ms
10	< 03 m 33 s 600 ms to 03 m 28 s 800 ms	< 03 m 28 s 800 ms to 03 m 22 s 200 ms	< 03 m 22 s 200 ms to 03 m 17 s 400 ms	< 03 m 17 s 400 ms to 03 m 15 s 0 ms	< 03 m 15 s 0 ms to 03 m 12 s 600 ms	< 03 m 12 s 600 ms to 03 m 12 s 0 ms	< 03 m 12 s 0 ms
11	< 03 m 27 s 600 ms to 03 m 22 s 800 ms	< 03 m 22 s 800 ms to 03 m 16 s 200 ms	< 03 m 16 s 200 ms to 03 m 11 s 400 ms	< 03 m 11 s 400 ms to 03 m 09 s 0 ms	< 03 m 09 s 0 ms to 03 m 06 s 600 ms	< 03 m 06 s 600 ms to 03 m 06 s 0 ms	< 03 m 06 s 0 ms
12	< 03 m 06 s 0 ms to 03 m 06 s 0 ms	< 03 m 06 s 0 ms to 02 m 52 s 200 ms	< 02 m 52 s 200 ms to 02 m 43 s 200 ms	< 02 m 43 s 200 ms to 02 m 39 s 0 ms	< 02 m 39 s 0 ms to 02 m 31 s 200 ms	< 02 m 31 s 200 ms to 02 m 30 s 600 ms	< 02 m 30 s 600 ms
13	< 02 m 18 s 0 ms to 02 m 14 s 400 ms	< 02 m 14 s 400 ms to 02 m 08 s 400 ms	< 02 m 08 s 400 ms to 02 m 04 s 800 ms	< 02 m 04 s 800 ms to 02 m 03 s 0 ms	< 02 m 03 s 0 ms to 02 m 00 s 600 ms	< 02 m 00 s 600 ms to 02 m 00 s 0 ms	< 02 m 00 s 0 ms
14	< 02 m 06 s 0 ms to 02 m 08 s 400 ms	< 02 m 08 s 400 ms to 01 m 33 s 600 ms	< 01 m 33 s 600 ms to 01 m 31 s 800 ms	< 01 m 31 s 800 ms to 01 m 30 s 600 ms	< 01 m 30 s 600 ms to 01 m 31 s 800 ms	< 01 m 31 s 800 ms to 01 m 30 s 600 ms	< 01 m 30 s 600 ms
15	< 02 m 00 s 0 ms to 01 m 34 s 800 ms	< 01 m 34 s 800 ms to 01 m 33 s 0 ms	< 01 m 33 s 0 ms to 01 m 31 s 800 ms	< 01 m 31 s 800 ms to 01 m 30 s 600 ms	< 01 m 30 s 600 ms to 01 m 31 s 800 ms	< 01 m 31 s 800 ms to 01 m 30 s 600 ms	< 01 m 30 s 600 ms
16	< 01 m 34 s 800 ms to 01 m 34 s 200 ms	< 01 m 34 s 200 ms to 01 m 32 s 400 ms	< 01 m 32 s 400 ms to 01 m 31 s 200 ms	< 01 m 31 s 200 ms to 01 m 30 s 600 ms	< 01 m 30 s 600 ms to 01 m 31 s 200 ms	< 01 m 31 s 200 ms to 01 m 30 s 600 ms	< 01 m 30 s 600 ms
17	< 01 m 33 s 600 ms to 01 m 33 s 0 ms	< 01 m 33 s 0 ms to 01 m 31 s 200 ms	< 01 m 31 s 200 ms to 01 m 30 s 0 ms	< 01 m 30 s 0 ms to 01 m 29 s 400 ms	< 01 m 29 s 400 ms to 01 m 30 s 0 ms	< 01 m 30 s 0 ms to 01 m 29 s 400 ms	< 01 m 29 s 400 ms
18	< 01 m 32 s 400 ms to 01 m 31 s 800 ms	< 01 m 31 s 800 ms to 01 m 29 s 400 ms	< 01 m 29 s 400 ms to 01 m 27 s 0 ms	< 01 m 27 s 0 ms to 01 m 25 s 200 ms	< 01 m 25 s 200 ms to 01 m 27 s 0 ms	< 01 m 27 s 0 ms to 01 m 25 s 200 ms	< 01 m 25 s 200 ms

7.14 Cardiovascular Endurance - 600 m Run/Walk - Girls

Age	L1 (Work Harder)	L2 (Must Improve)	L3 (Can do Better)	L4 (Good)	L5 (Very Good)	L6 (Athletic)	L7 (Sports Fit)
-----	------------------	-------------------	--------------------	-----------	----------------	---------------	-----------------

9	< 04 m 15 s 0 ms to 04 m 06 s 600 ms	< 04 m 06 s 600 ms to 03 m 54 s 600 ms	< 03 m 54 s 600 ms to 03 m 45 s 600 ms	< 03 m 45 s 600 ms to 03 m 41 s 400 ms	< 03 m 41 s 400 ms to 03 m 36 s 0 ms	< 03 m 36 s 0 ms to 03 m 35 s 400 ms	< 03 m 35 s 400 ms
10	< 04 m 06 s 0 ms to 03 m 57 s 0 ms	< 03 m 57 s 0 ms to 03 m 44 s 400 ms	< 03 m 44 s 400 ms to 03 m 34 s 800 ms	< 03 m 34 s 800 ms to 03 m 30 s 600 ms	< 03 m 30 s 600 ms to 03 m 24 s 600 ms	< 03 m 24 s 600 ms to 03 m 24 s 0 ms	< 03 m 24 s 0 ms
11	< 04 m 00 s 600 ms to 03 m 51 s 600 ms	< 03 m 51 s 600 ms to 03 m 38 s 400 ms	< 03 m 38 s 400 ms to 03 m 28 s 800 ms	< 03 m 28 s 800 ms to 03 m 24 s 600 ms	< 03 m 24 s 600 ms to 03 m 18 s 600 ms	< 03 m 18 s 600 ms to 03 m 18 s 0 ms	< 03 m 18 s 0 ms
12	< 03 m 30 s 0 ms to 03 m 24 s 0 ms	< 03 m 24 s 0 ms to 03 m 14 s 400 ms	< 03 m 14 s 400 ms to 03 m 07 s 800 ms	< 03 m 07 s 800 ms to 03 m 04 s 800 ms	< 03 m 04 s 800 ms to 03 m 00 s 600 ms	< 03 m 00 s 600 ms to 03 m 00 s 0 ms	< 03 m 00 s 0 ms
13	< 03 m 00 s 0 ms to 02 m 49 s 800 ms	< 02 m 49 s 800 ms to 02 m 34 s 800 ms	< 02 m 34 s 800 ms to 02 m 24 s 0 ms	< 02 m 24 s 0 ms to 02 m 19 s 200 ms	< 02 m 19 s 200 ms to 02 m 12 s 600 ms	< 02 m 12 s 600 ms to 02 m 12 s 0 ms	< 02 m 12 s 0 ms
14	< 02 m 18 s 0 ms to 02 m 14 s 400 ms	< 02 m 14 s 400 ms to 02 m 08 s 400 ms	< 02 m 08 s 400 ms to 02 m 04 s 800 ms	< 02 m 04 s 800 ms to 02 m 03 s 0 ms	< 02 m 03 s 0 ms to 02 m 04 s 800 ms	< 02 m 04 s 800 ms to 02 m 03 s 0 ms	< 02 m 03 s 0 ms
15	< 02 m 06 s 0 ms to 02 m 08 s 400 ms	< 02 m 08 s 400 ms to 01 m 33 s 600 ms	< 01 m 33 s 600 ms to 01 m 31 s 800 ms	< 01 m 31 s 800 ms to 01 m 30 s 600 ms	< 01 m 30 s 600 ms to 01 m 31 s 800 ms	< 01 m 31 s 800 ms to 01 m 30 s 600 ms	< 01 m 30 s 600 ms
16	< 02 m 00 s 0 ms to 01 m 34 s 800 ms	< 01 m 34 s 800 ms to 01 m 33 s 0 ms	< 01 m 33 s 0 ms to 01 m 31 s 800 ms	< 01 m 31 s 800 ms to 01 m 30 s 600 ms	< 01 m 30 s 600 ms to 01 m 31 s 800 ms	< 01 m 31 s 800 ms to 01 m 30 s 600 ms	< 01 m 30 s 600 ms
17	< 01 m 34 s 800 ms to 01 m 34 s 200 ms	< 01 m 34 s 200 ms to 01 m 32 s 400 ms	< 01 m 32 s 400 ms to 01 m 31 s 200 ms	< 01 m 31 s 200 ms to 01 m 30 s 600 ms	< 01 m 30 s 600 ms to 01 m 31 s 200 ms	< 01 m 31 s 200 ms to 01 m 30 s 600 ms	< 01 m 30 s 600 ms
18	< 01 m 33 s 600 ms to 01 m 33 s 0 ms	< 01 m 33 s 0 ms to 01 m 31 s 200 ms	< 01 m 31 s 200 ms to 01 m 30 s 0 ms	< 01 m 30 s 0 ms to 01 m 29 s 400 ms	< 01 m 29 s 400 ms to 01 m 30 s 0 ms	< 01 m 30 s 0 ms to 01 m 29 s 400 ms	< 01 m 29 s 400 ms

7.15 Speed Test - 50 m Dash - Boys

Age	L1 (Work Harder)	L2 (Must Improve)	L3 (Can do Better)	L4 (Good)	L5 (Very Good)	L6 (Athletic)	L7 (Sports Fit)
9	< 00 m 10 s 800 ms to 00 m 10 s 300	< 00 m 10 s 300 ms to 00 m 09 s 800	< 00 m 09 s 800 ms to 00 m 09 s 300	< 00 m 09 s 300 ms to 00 m 09 s 100	< 00 m 09 s 100 ms to 00 m 09 s 0 ms	< 00 m 09 s 0 ms to 00 m 08 s 600 ms	< 00 m 08 s 600 ms

	ms	ms	ms	ms			
10	< 00 m 10 s 400 ms to 00 m 10 s 0 ms	< 00 m 10 s 0 ms to 00 m 09 s 500 ms	< 00 m 09 s 500 ms to 00 m 09 s 100 ms	< 00 m 09 s 100 ms to 00 m 08 s 900 ms	< 00 m 08 s 900 ms to 00 m 08 s 300 ms	< 00 m 08 s 300 ms to 00 m 08 s 300 ms	< 00 m 08 s 300 ms
11	< 00 m 10 s 100 ms to 00 m 09 s 700 ms	< 00 m 09 s 700 ms to 00 m 09 s 200 ms	< 00 m 09 s 200 ms to 00 m 08 s 800 ms	< 00 m 08 s 800 ms to 00 m 08 s 600 ms	< 00 m 08 s 600 ms to 00 m 08 s 100 ms	< 00 m 08 s 100 ms to 00 m 08 s 100 ms	< 00 m 08 s 100 ms
12	< 00 m 09 s 800 ms to 00 m 09 s 400 ms	< 00 m 09 s 400 ms to 00 m 08 s 900 ms	< 00 m 08 s 900 ms to 00 m 08 s 500 ms	< 00 m 08 s 500 ms to 00 m 08 s 300 ms	< 00 m 08 s 300 ms to 00 m 07 s 800 ms	< 00 m 07 s 800 ms to 00 m 07 s 800 ms	< 00 m 07 s 800 ms
13	< 00 m 09 s 400 ms to 00 m 09 s 100 ms	< 00 m 09 s 100 ms to 00 m 08 s 700 ms	< 00 m 08 s 700 ms to 00 m 08 s 300 ms	< 00 m 08 s 300 ms to 00 m 08 s 0 ms	< 00 m 08 s 0 ms to 00 m 07 s 700 ms	< 00 m 07 s 700 ms to 00 m 07 s 700 ms	< 00 m 07 s 700 ms
14	< 00 m 09 s 100 ms to 00 m 08 s 900 ms	< 00 m 08 s 900 ms to 00 m 08 s 500 ms	< 00 m 08 s 500 ms to 00 m 08 s 0 ms	< 00 m 08 s 0 ms to 00 m 07 s 800 ms	< 00 m 07 s 800 ms to 00 m 07 s 500 ms	< 00 m 07 s 500 ms to 00 m 07 s 600 ms	< 00 m 07 s 600 ms
15	< 00 m 08 s 900 ms to 00 m 08 s 700 ms	< 00 m 08 s 700 ms to 00 m 08 s 300 ms	< 00 m 08 s 300 ms to 00 m 07 s 800 ms	< 00 m 07 s 800 ms to 00 m 07 s 700 ms	< 00 m 07 s 700 ms to 00 m 07 s 300 ms	< 00 m 07 s 300 ms to 00 m 07 s 400 ms	< 00 m 07 s 400 ms
16	< 00 m 08 s 700 ms to 00 m 08 s 500 ms	< 00 m 08 s 500 ms to 00 m 08 s 0 ms	< 00 m 08 s 0 ms to 00 m 07 s 700 ms	< 00 m 07 s 700 ms to 00 m 07 s 600 ms	< 00 m 07 s 600 ms to 00 m 07 s 200 ms	< 00 m 07 s 200 ms to 00 m 07 s 200 ms	< 00 m 07 s 200 ms
17	< 00 m 08 s 500 ms to 00 m 08 s 300 ms	< 00 m 08 s 300 ms to 00 m 07 s 800 ms	< 00 m 07 s 800 ms to 00 m 07 s 600 ms	< 00 m 07 s 600 ms to 00 m 07 s 500 ms	< 00 m 07 s 500 ms to 00 m 07 s 100 ms	< 00 m 07 s 100 ms to 00 m 07 s 100 ms	< 00 m 07 s 100 ms
18	< 00 m 08 s 300 ms to 00 m 08 s 0 ms	< 00 m 08 s 0 ms to 00 m 07 s 700 ms	< 00 m 07 s 700 ms to 00 m 07 s 500 ms	< 00 m 07 s 500 ms to 00 m 07 s 300 ms	< 00 m 07 s 300 ms to 00 m 07 s 0 ms	< 00 m 07 s 0 ms to 00 m 07 s 0 ms	< 00 m 07 s 0 ms

7.16 Speed Test - 50 m Dash - Girls

Age	L1 (Work Harder)	L2 (Must Improve)	L3 (Can do Better)	L4 (Good)	L5 (Very Good)	L6 (Athletic)	L7 (Sports Fit)
9	< 00 m 11 s 100 ms to 00 m 10 s 600 ms	< 00 m 10 s 600 ms to 00 m 09 s 900 ms	< 00 m 09 s 900 ms to 00 m 09 s 500 ms	< 00 m 09 s 500 ms to 00 m 09 s 300 ms	< 00 m 09 s 300 ms to 00 m 09 s 100 ms	< 00 m 09 s 100 ms to 00 m 08 s 800 ms	< 00 m 08 s 800 ms
10	< 00 m 10 s	< 00 m 10 s	< 00 m 09 s	< 00 m 09 s	< 00 m 09 s	< 00 m 08 s	< 00 m 08 s

	700 ms to 00 m 10 s 200 ms	200 ms to 00 m 09 s 700 ms	700 ms to 00 m 09 s 300 ms	300 ms to 00 m 09 s 100 ms	100 ms to 00 m 08 s 800 ms	800 ms to 00 m 08 s 500 ms	500 ms
11	< 00 m 10 s 300 ms to 00 m 09 s 500 ms	< 00 m 09 s 500 ms to 00 m 09 s 0 ms	< 00 m 09 s 0 ms to 00 m 08 s 600 ms	< 00 m 08 s 600 ms to 00 m 08 s 400 ms	< 00 m 08 s 400 ms to 00 m 08 s 500 ms	< 00 m 08 s 500 ms to 00 m 08 s 300 ms	< 00 m 08 s 300 ms
12	< 00 m 10 s 0 ms to 00 m 09 s 500 ms	< 00 m 09 s 500 ms to 00 m 09 s 0 ms	< 00 m 09 s 0 ms to 00 m 08 s 600 ms	< 00 m 08 s 600 ms to 00 m 08 s 400 ms	< 00 m 08 s 400 ms to 00 m 08 s 200 ms	< 00 m 08 s 200 ms to 00 m 08 s 0 ms	< 00 m 08 s 0 ms
13	< 00 m 09 s 500 ms to 00 m 09 s 200 ms	< 00 m 09 s 200 ms to 00 m 08 s 800 ms	< 00 m 08 s 800 ms to 00 m 08 s 400 ms	< 00 m 08 s 400 ms to 00 m 08 s 100 ms	< 00 m 08 s 100 ms to 00 m 08 s 0 ms	< 00 m 08 s 0 ms to 00 m 07 s 800 ms	< 00 m 07 s 800 ms
14	< 00 m 09 s 200 ms to 00 m 09 s 0 ms	< 00 m 09 s 0 ms to 00 m 08 s 600 ms	< 00 m 08 s 600 ms to 00 m 08 s 100 ms	< 00 m 08 s 100 ms to 00 m 07 s 900 ms	< 00 m 07 s 900 ms to 00 m 07 s 800 ms	< 00 m 07 s 800 ms to 00 m 07 s 600 ms	< 00 m 07 s 600 ms
15	< 00 m 09 s 0 ms to 00 m 08 s 800 ms	< 00 m 08 s 800 ms to 00 m 08 s 400 ms	< 00 m 08 s 400 ms to 00 m 07 s 900 ms	< 00 m 07 s 900 ms to 00 m 07 s 600 ms	< 00 m 07 s 600 ms to 00 m 07 s 700 ms	< 00 m 07 s 700 ms to 00 m 07 s 400 ms	< 00 m 07 s 400 ms
16	< 00 m 08 s 800 ms to 00 m 08 s 600 ms	< 00 m 08 s 600 ms to 00 m 08 s 100 ms	< 00 m 08 s 100 ms to 00 m 07 s 600 ms	< 00 m 07 s 600 ms to 00 m 07 s 400 ms	< 00 m 07 s 400 ms to 00 m 07 s 500 ms	< 00 m 07 s 500 ms to 00 m 07 s 200 ms	< 00 m 07 s 200 ms
17	< 00 m 08 s 600 ms to 00 m 08 s 400 ms	< 00 m 08 s 400 ms to 00 m 07 s 900 ms	< 00 m 07 s 900 ms to 00 m 07 s 400 ms	< 00 m 07 s 400 ms to 00 m 07 s 300 ms	< 00 m 07 s 300 ms to 00 m 07 s 400 ms	< 00 m 07 s 400 ms to 00 m 07 s 0 ms	< 00 m 07 s 0 ms
18	< 00 m 08 s 0 ms to 00 m 07 s 800 ms	< 00 m 07 s 800 ms to 00 m 07 s 600 ms	< 00 m 07 s 600 ms to 00 m 07 s 300 ms	< 00 m 07 s 300 ms to 00 m 07 s 100 ms	< 00 m 07 s 100 ms to 00 m 07 s 300 ms	< 00 m 07 s 300 ms to 00 m 06 s 800 ms	< 00 m 06 s 800 ms

7.17 Body Mass Index

Age	Gender	Underweight	Normal	Overweight	Obese
5	Female	13.4	15.2	17	18.8
5	Male	13.8	15.4	17	18.4
6	Female	13.4	15.2	17	18.8
6	Male	13.8	15.4	17	18.4
7	Female	13.4	15.4	17.6	19.6
7	Male	13.8	15.4	17.4	19.2
8	Female	13.6	15.8	18.2	20.6
8	Male	13.8	15.8	18	20
9	Female	13.8	16.2	19	21.6
9	Male	14	16.2	18.6	21
10	Female	14	16.8	19.8	23
10	Male	14.2	16.6	19.4	22
11	Female	14.4	17.4	20.8	24
11	Male	14.6	17.2	20.2	23.2
12	Female	14.8	18	21.8	25
12	Male	15	17.8	21	24.2
13	Female	15.2	18.6	22.6	26.2
13	Male	15.4	18.4	21.8	25.2
14	Female	15.8	19.2	23.4	27.2
14	Male	16	19.2	22.6	26
15	Female	16.2	19.8	24	28
15	Male	16.6	19.8	23.4	26.8
16	Female	16.8	20.4	24.6	28.8
16	Male	17.2	20.6	24.2	27.6
17	Female	17.2	21	25.2	29.6
17	Male	17.8	21.2	25	28.2
18	Female	17.6	21.2	25.6	30.1
18	Male	18.4	21.8	25.6	29



for more details, visit

<http://fitindia.gov.in>